

iTrack Vera Series

**TL19-30W**

Reflector



Technical Parameters:

Name	Parameters
Light source:	COB
Input Voltage:	AC220~240V 50/60Hz
LED Current:	700mA, 35-37V
Rated life:	>50,000 hours
Operating temperature:	-20°C~40°C
Storage temperature:	-30°C~60°C
Certificate:	TUV/CE/RoHS
Weight:	2.0KG

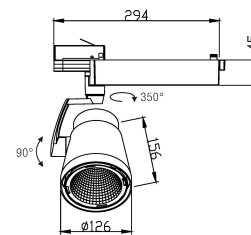

Ordering Information:

○ White ● Black

Power	CRI	Beam Angle	Luminous	CCT	Housing	Part Number
30W	>80	▲ 12°	2830 lm	3000K	○	TL194-30W-830-W-12
					●	TL194-30W-830-B-12
		3030 lm	4000K	○	TL194-30W-840-W-12	
				●	TL194-30W-840-B-12	
		▲ 20°	2860 lm	3000K	○	TL194-30W-830-W-20
					●	TL194-30W-830-B-20
	3050 lm	4000K	○	TL194-30W-840-W-20		
			●	TL194-30W-840-B-20		
	▲ 45°	2740 lm	3000K	○	TL194-30W-830-W-45	
				●	TL194-30W-830-B-45	
	2920 lm	4000K	○	TL194-30W-840-W-45		
			●	TL194-30W-840-B-45		
>90	▲ 12°	▲ 12°	2590 lm	3000K	○	TL194-30W-930-W-12
					●	TL194-30W-930-B-12
		2690 lm	4000K	○	TL194-30W-940-W-12	
				●	TL194-30W-940-B-12	
		▲ 20°	2600 lm	3000K	○	TL194-30W-930-W-20
					●	TL194-30W-930-B-20
	2720 lm	4000K	○	TL194-30W-940-W-20		
			●	TL194-30W-940-B-20		
	▲ 45°	2480 lm	3000K	○	TL194-30W-930-W-45	
				●	TL194-30W-930-B-45	
	2600 lm	4000K	○	TL194-30W-940-W-45		
			●	TL194-30W-940-B-45		

Technical Data test pattern

CRI80 12°

3000K

4000K

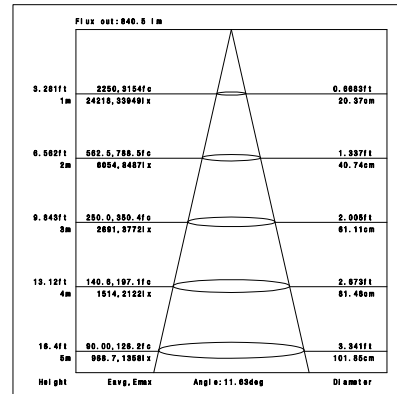
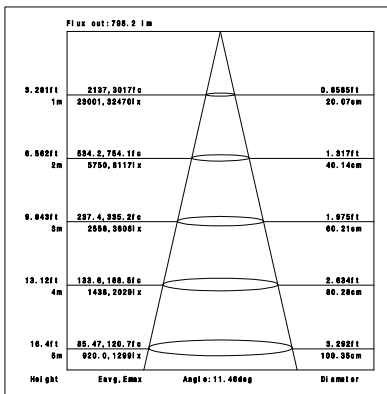
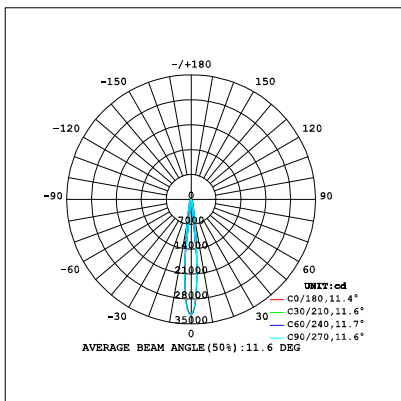

CRI80 20°

3000K

4000K

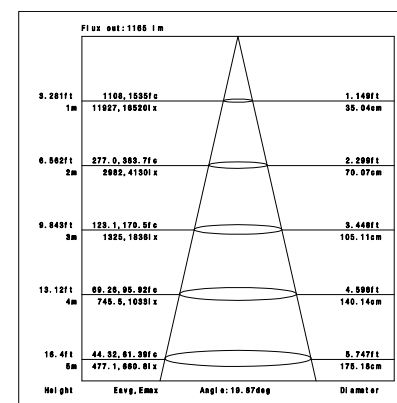
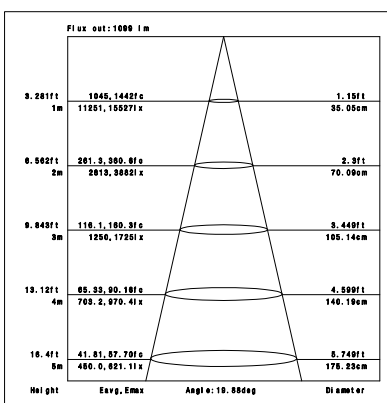
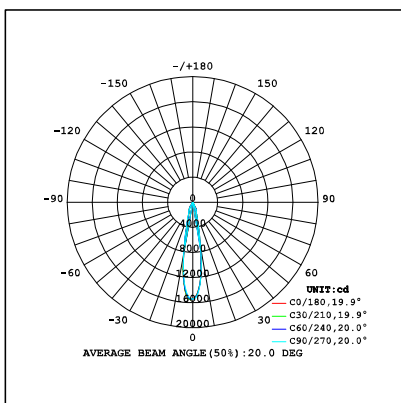

CRI80 45°

3000K

4000K

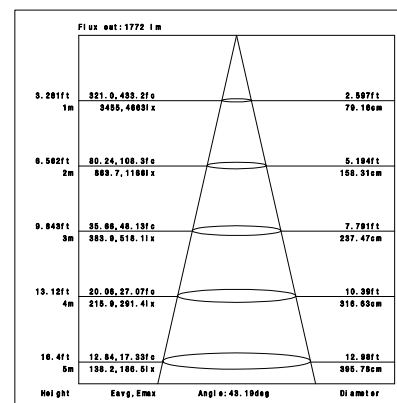
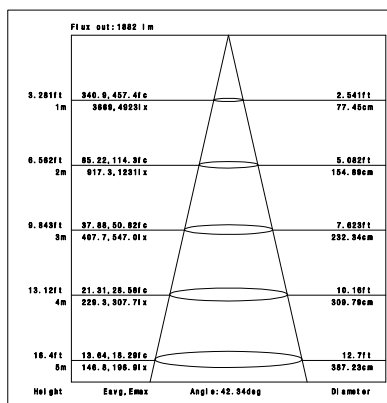
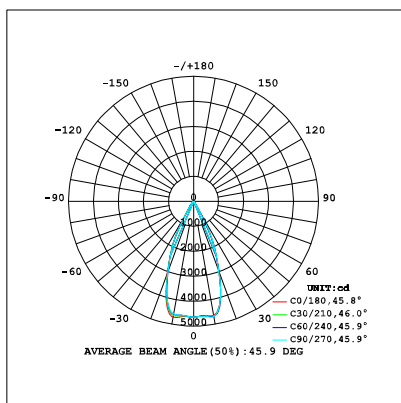

CRI90 12°

3000K

4000K

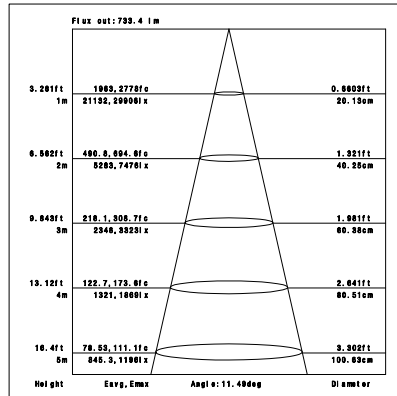
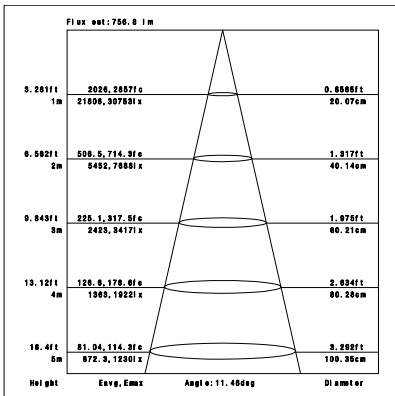
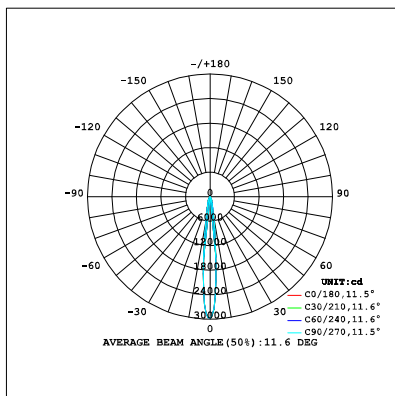

CRI90 20°

3000K

4000K

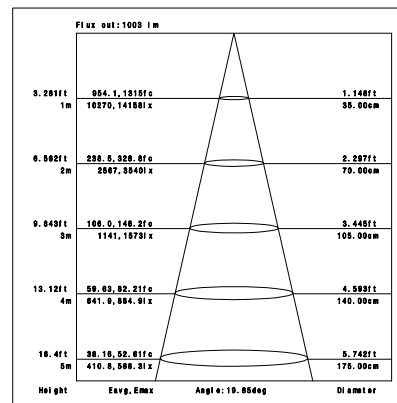
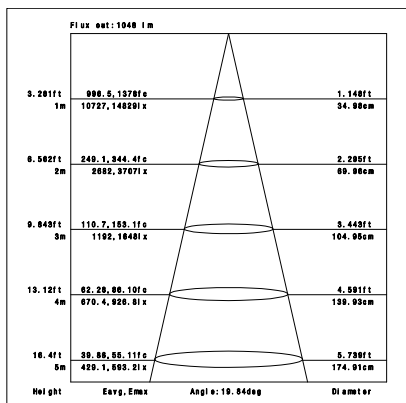
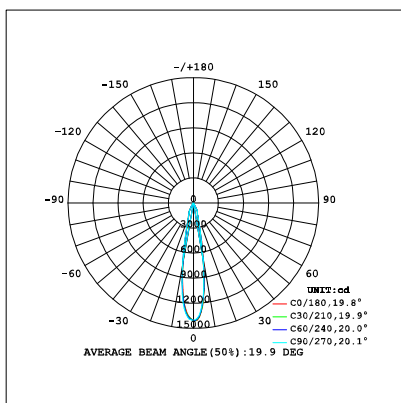

CRI90 45°

3000K

4000K

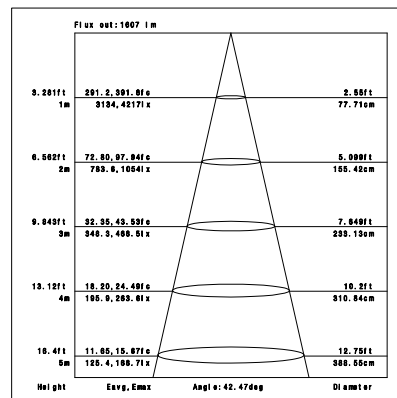
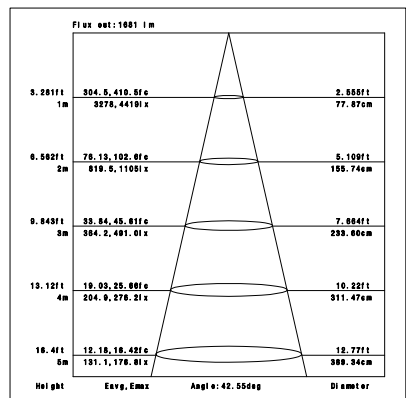
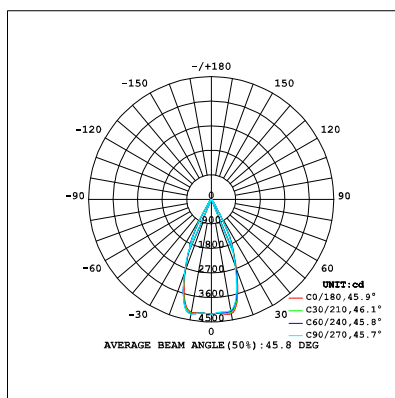

Installation instruction

Adaptor installation diagram

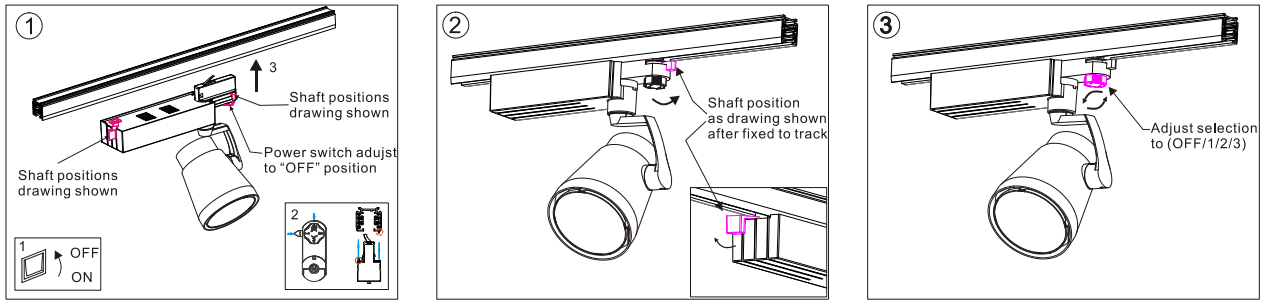

Adaptor disassembly diagram

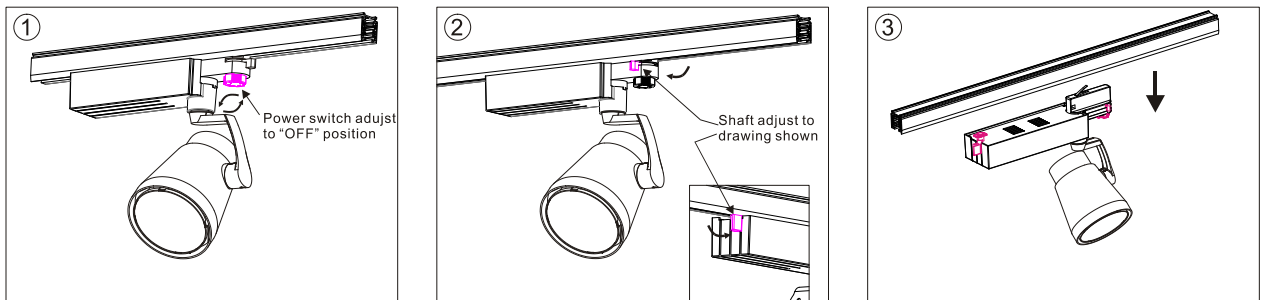

Cautions

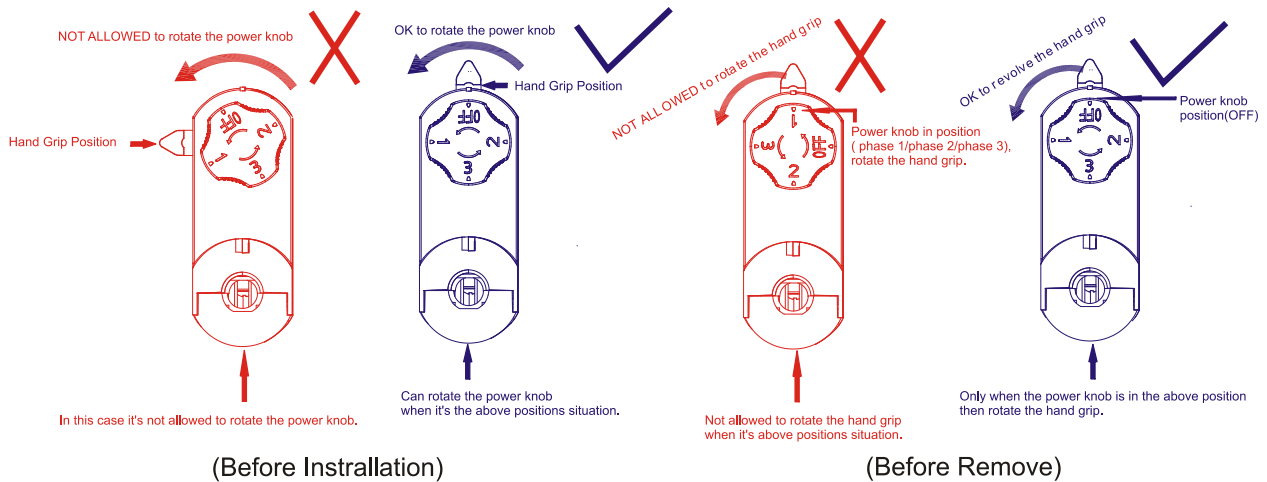

Packaging:

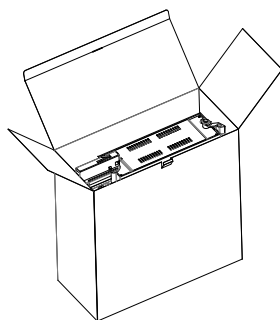

**Box**  
 L320\*W140\*H320 mm  
 1pc/box  
 GW: 2.0kg/box

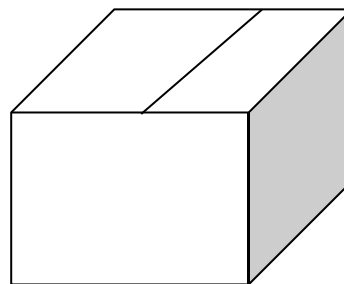

**Outer carton**  
 L670Xw500xH350mm  
 6 pcs/CTN  
 GW: 14kg/carton

Product naming system

**TL ( X ) XX X (H) – XW – X XX – X- XX**

