

Halolite Series

**M01-8W**

Optical Lens

Technical Parameters:

Name	Parameters
Light source:	COB
Input Voltage:	AC220~240V 50/60Hz
LED Current:	350mA (17.8V)
Rated life:	>50,000 hours
Operating temperature:	-20°C~40°C
Storage temperature:	-30°C~60°C
Certificate:	CE/RoHS
Dimmability:	Dimmable Optional
Weight:	0.087KG (M011) / 0.14KG (M0112) 0.18KG (M0113) / 0.18KG (M0114) 0.18KG (M0115) / 0.21KG (M0116)

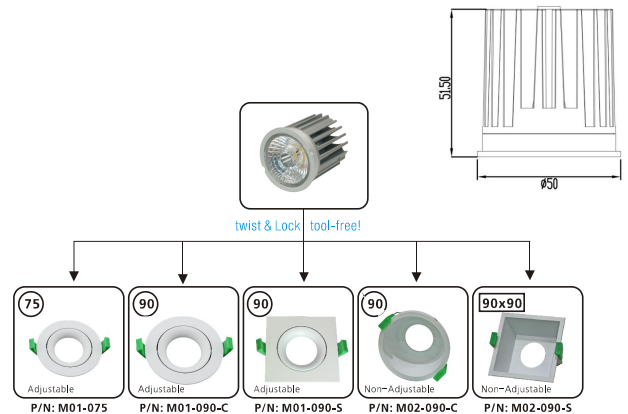

Ordering Information:

○ Silver gray

Power	CRI	Beam Angle	Luminous	CCT	Housing	Part Number		
8W	>80	▲ 15°	530 lm	2700K	○	M012*-8W-827-S-15		
			600 lm	3000K	○	M012*-8W-830-S-15		
			650 lm	4000K	○	M012*-8W-840-S-15		
		▲ 24°	520 lm	2700K	○	M012*-8W-827-S-24		
			640 lm	3000K	○	M012*-8W-830-S-24		
			710 lm	4000K	○	M012*-8W-840-S-24		
		▲ 38°	530 lm	2700K	○	M012*-8W-827-S-38		
			630 lm	3000K	○	M012*-8W-830-S-38		
			680 lm	4000K	○	M012*-8W-840-S-38		
		▲ 60°	530 lm	2700K	○	M012*-8W-827-S-60		
			650 lm	3000K	○	M012*-8W-830-S-60		
			700 lm	4000K	○	M012*-8W-840-S-60		
		>90	>90	▲ 15°	510 lm	2700K	○	M012*-8W-927-S-15
					610 lm	3000K	○	M012*-8W-930-S-15
					650 lm	3000K	○	M012*-8W-930-S-24
				▲ 24°	500 lm	2700K	○	M012*-8W-927-S-24
					650 lm	3000K	○	M012*-8W-930-S-24
					650 lm	3000K	○	M012*-8W-930-S-24
▲ 38°	510 lm			2700K	○	M012*-8W-927-S-38		
	630 lm			3000K	○	M012*-8W-930-S-38		
	650 lm			3000K	○	M012*-8W-930-S-38		
▲ 60°	510 lm			2700K	○	M012*-8W-927-S-60		
	650 lm			3000K	○	M012*-8W-930-S-60		
	650 lm			3000K	○	M012*-8W-930-S-60		

\*\*\*: 1: S-MR16; 2: M01-075; 3: M01-090-C; 4: M01-090-S; 5: M02-090-C; 6: M02-090-S

Technical Data test pattern

CRI80 15°

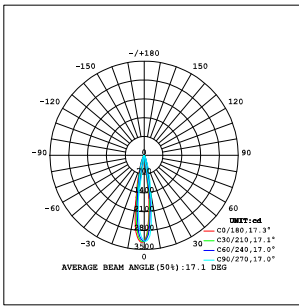

2700K

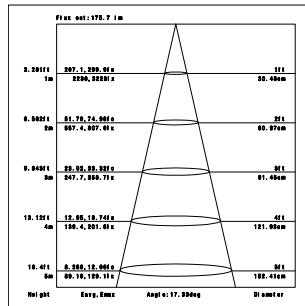

3000K

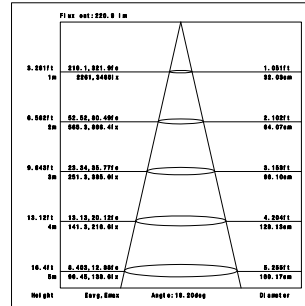

4000K

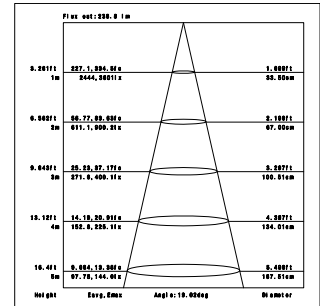

CRI80 24°

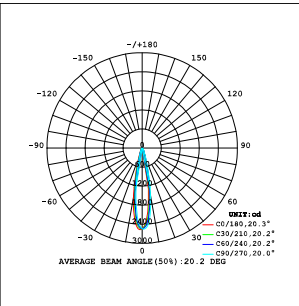

2700K

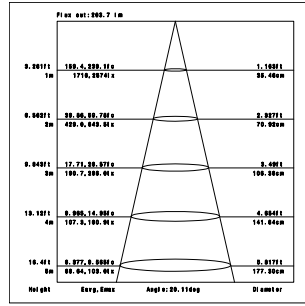

3000K

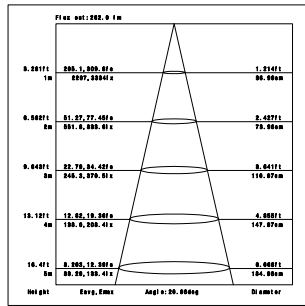

4000K

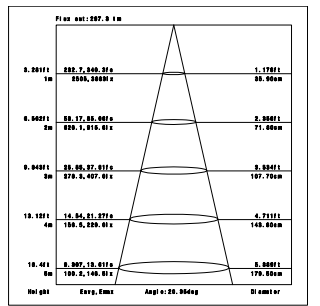

CRI80 38°

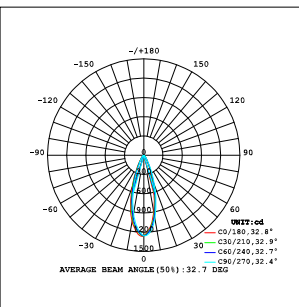

2700K

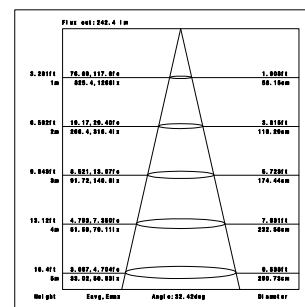

3000K

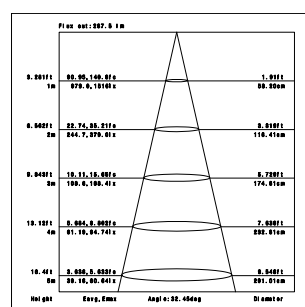

4000K

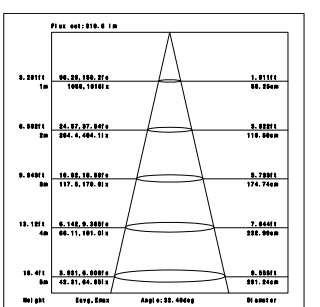

CRI80 60°

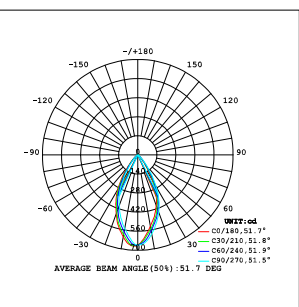

2700K

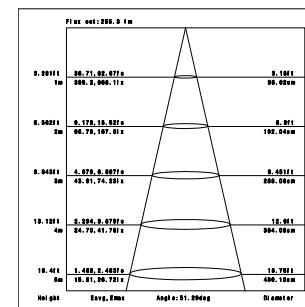

3000K

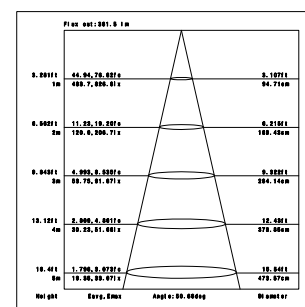

4000K

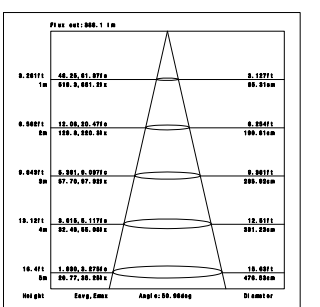

CRI90 15°

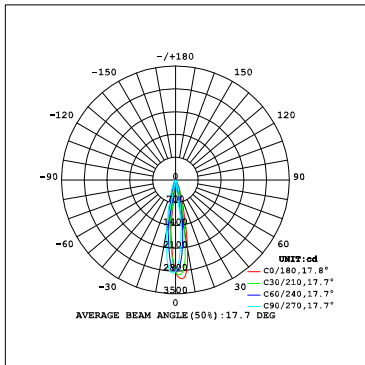

2700K

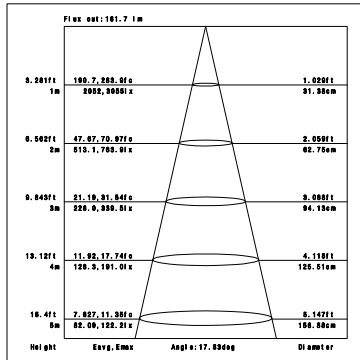

3000K

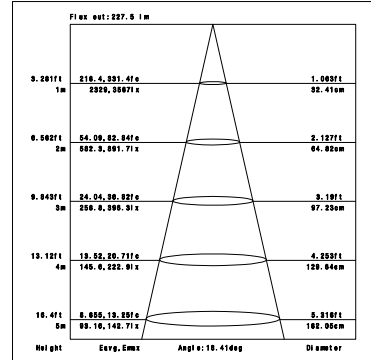

CRI90 24°

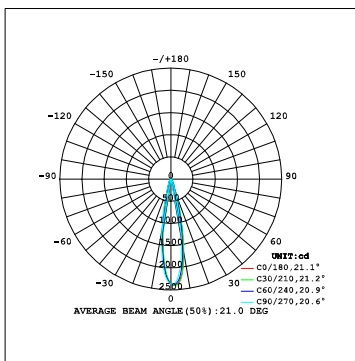

2700K

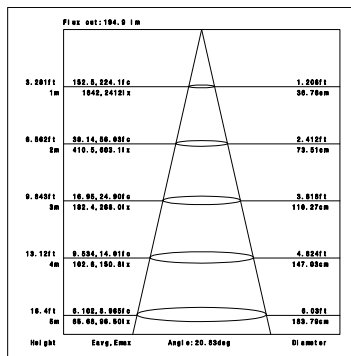

3000K

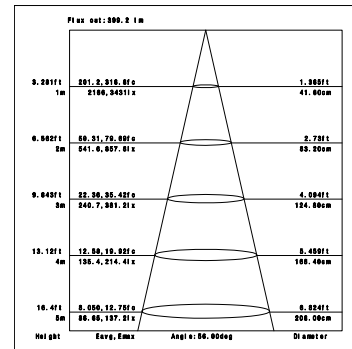

CRI90 38°

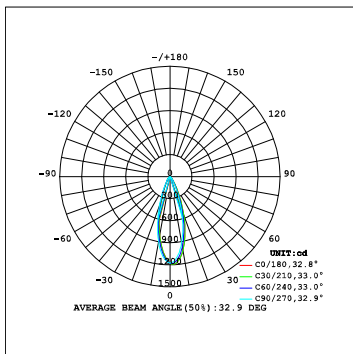

2700K

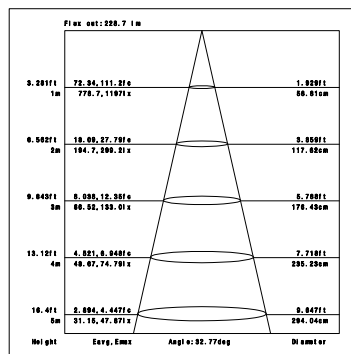

3000K

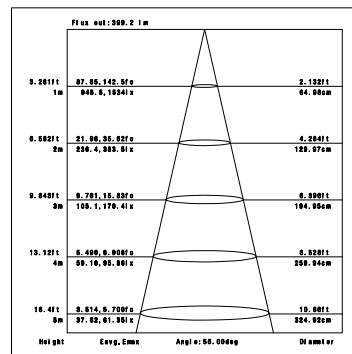

CRI90 60°

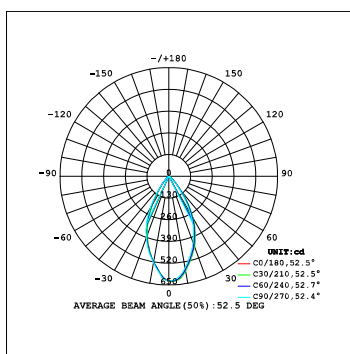

2700K

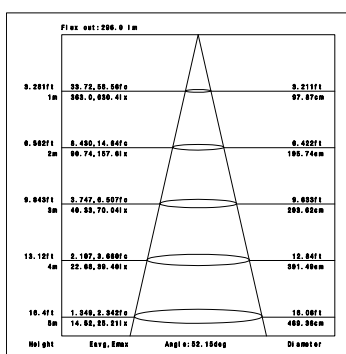

3000K

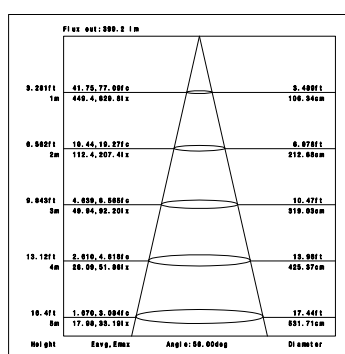

Installation instruction

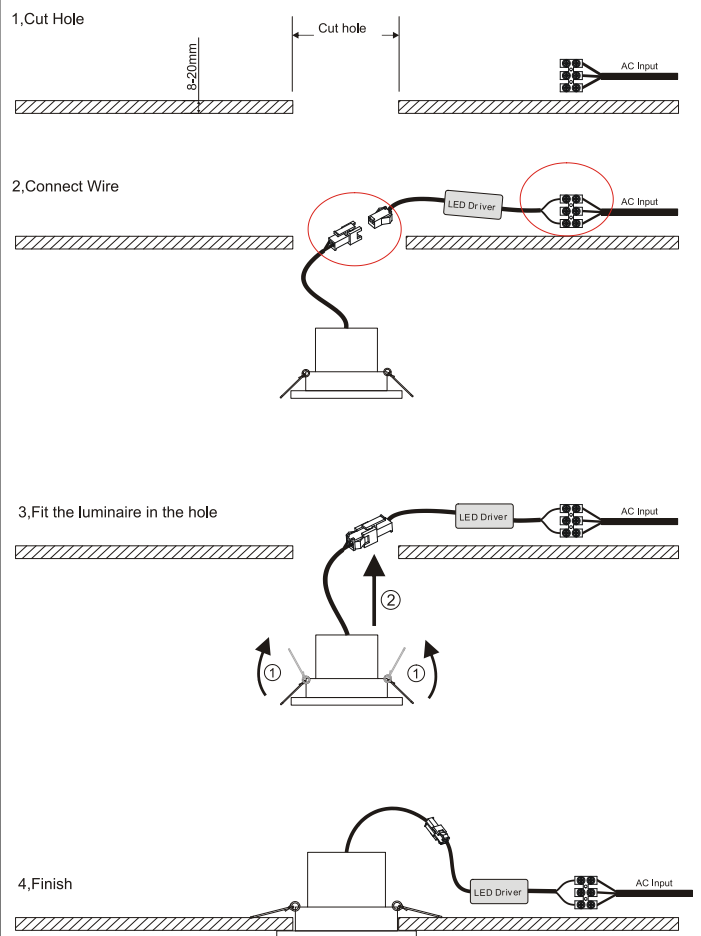
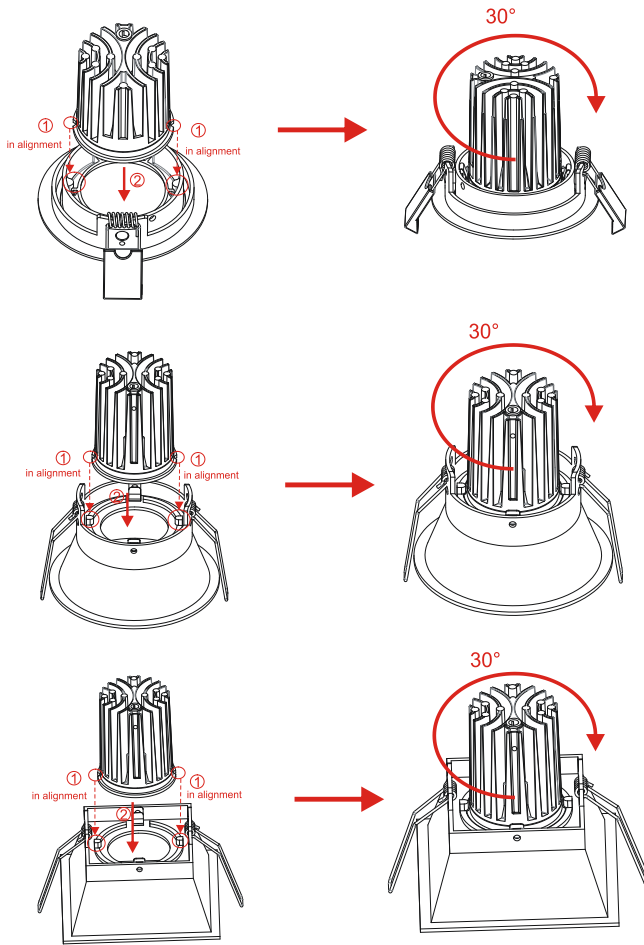

Packaging:

**M012 (Without driver)**

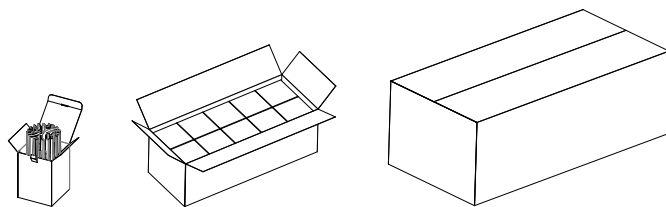

<b>Box</b> L52*W52*H76mm 1pc/box GW: 0.1kg/box	<b>Inner box</b> L270*W110*H95mm 10pc/box GW: 1.05kg/box	<b>Outer carton</b> L600*W300*H230mm 100pcs/CTN GW: 11.5kg/carton
---	---	--

**M012 (With driver)**

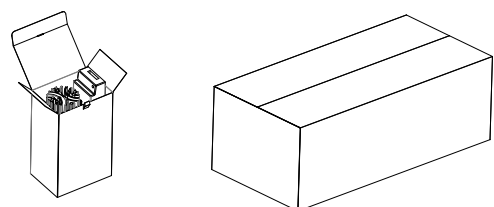

<b>Box</b> L96*W65*H140mm 1pc/box GW: 0.15kg/box	<b>Outer carton</b> L600*W300*H230mm 36pcs/CTN GW: 6.5kg/carton
---	--

**M0122**

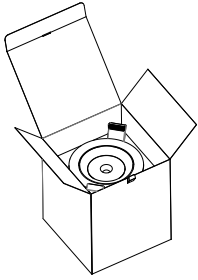

**Box**  
 L105\*W105\*H130mm  
 1pc/box  
 GW: 0.25kg/box

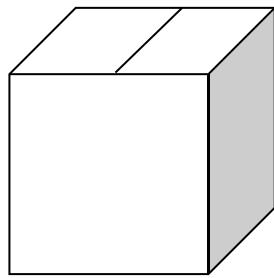

**Outer carton**  
 L450\*W450\*H410mm  
 48pcs/CTN  
 GW: 14kg/carton

**M0123**

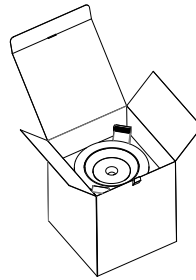

**Box**  
 L105\*W105\*H130mm  
 1pc/box  
 GW: 0.3kg/box

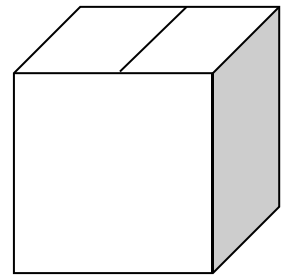

**Outer carton**  
 L450\*W450\*H410mm  
 48pcs/CTN  
 GW: 16kg/carton

**M0124/M0126**

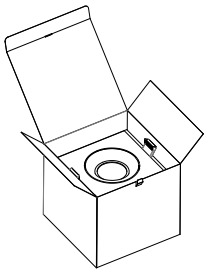

**Box**  
 L130\*W130\*H120mm  
 1pc/box  
 GW: 0.35kg/box

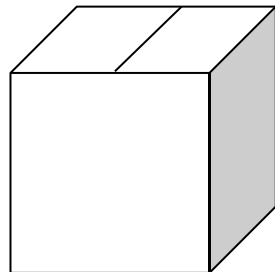

**Outer carton**  
 L540\*W420\*H280mm  
 24pcs/CTN  
 GW: 9.5kg/carton

**M0125**

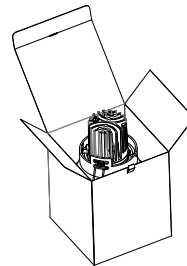

**Box**  
 L105\*W105\*H130mm  
 1pc/box  
 GW: 0.3kg/box

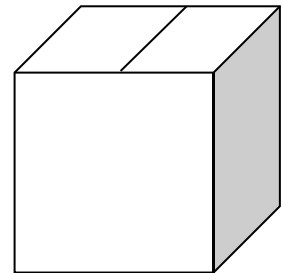

**Outer carton**  
 L450\*W450\*H410mm  
 48pcs/CTN  
 GW: 16kg/carton

Product naming system

