

Halolite Series

M01-8W

Reflector



Technical Parameters:

Name	Parameters
Light source:	COB
Input Voltage:	AC220~240V 50/60Hz
LED Current:	350mA (17.8V)
Rated life:	>50,000 hours
Operating temperature:	-20°C~40°C
Storage temperature:	-30°C~60°C
Certificate:	CE/RoHS
Dimmability:	Dimmable Optional
Weight:	0.087KG (M011) / 0.14KG (M0112) 0.18KG (M0113) / 0.18KG (M0114) 0.18KG (M0115) / 0.21KG (M0116)

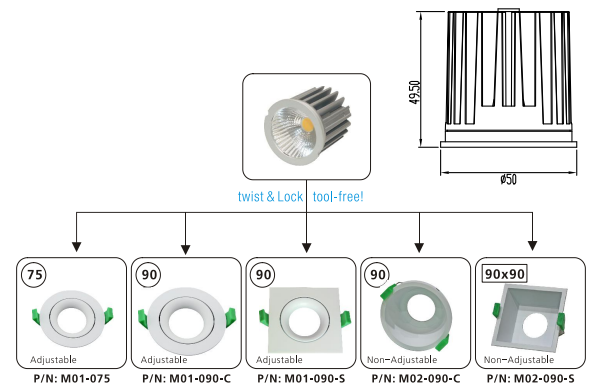

Ordering Information:

○ Silver gray

Power	CRI	Beam Angle	Luminous	CCT	Housing	Part Number		
8W	>80	▲ 16°	510 lm	2700K	○	M011*-8W-827-S-16		
			610 lm	3000K	○	M011*-8W-830-S-16		
			670 lm	4000K	○	M011*-8W-840-S-16		
		▲ 28°	490 lm	2700K	○	M011*-8W-827-S-28		
			600 lm	3000K	○	M011*-8W-830-S-28		
			660 lm	4000K	○	M011*-8W-840-S-28		
		▲ 40°	500 lm	2700K	○	M011*-8W-827-S-40		
			610 lm	3000K	○	M011*-8W-830-S-40		
			670 lm	4000K	○	M011*-8W-840-S-40		
		▲ 60°	500 lm	2700K	○	M011*-8W-827-S-60		
			600 lm	3000K	○	M011*-8W-830-S-60		
			650 lm	4000K	○	M011*-8W-840-S-60		
		>90	>90	▲ 16°	490 lm	2700K	○	M011*-8W-927-S-16
					610 lm	3000K	○	M011*-8W-930-S-16
					600 lm	3000K	○	M011*-8W-930-S-28
				▲ 28°	460 lm	2700K	○	M011*-8W-927-S-28
					600 lm	3000K	○	M011*-8W-930-S-28
					480 lm	2700K	○	M011*-8W-927-S-40
▲ 40°	610 lm			3000K	○	M011*-8W-930-S-40		
	460 lm			2700K	○	M011*-8W-927-S-60		
	600 lm			3000K	○	M011*-8W-930-S-60		

***: 1: S-MR16; 2: M01-075; 3: M01-090-C; 4: M01-090-S; 5: M02-090-C; 6: M02-090-S

Technical Data test pattern

CRI80 16°

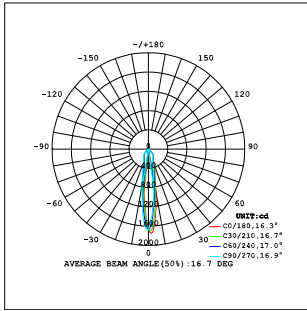

2700K

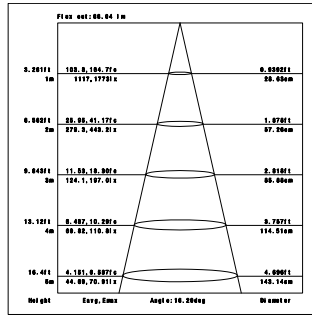

3000K

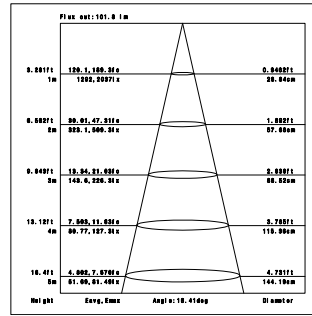

4000K

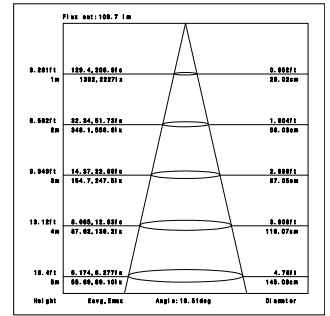

CRI80 28°

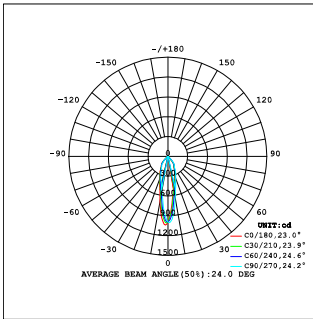

2700K

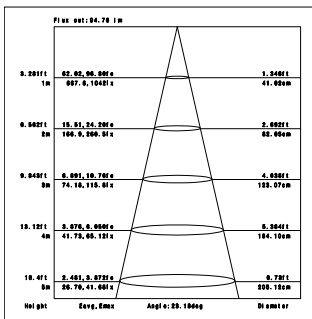

3000K

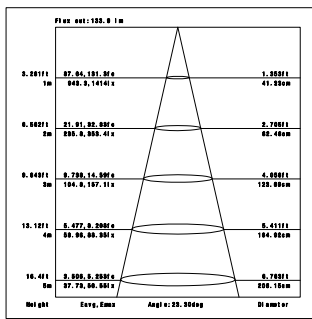

4000K

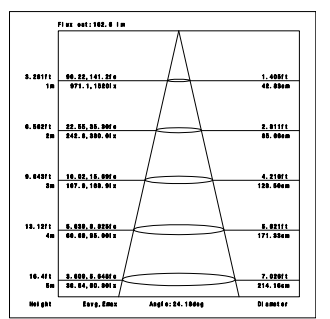

CRI80 40°

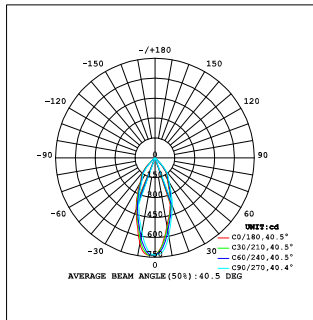

2700K

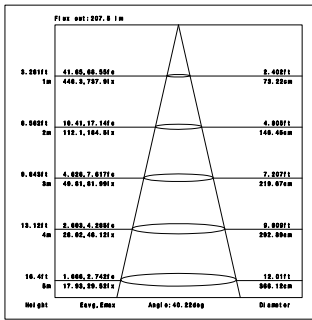

3000K

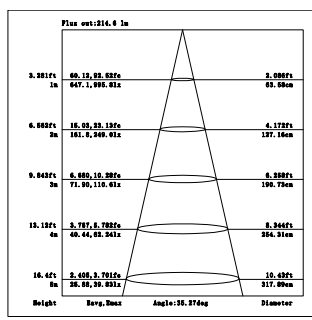

4000K

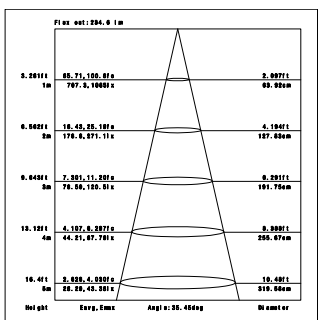

CRI80 60°

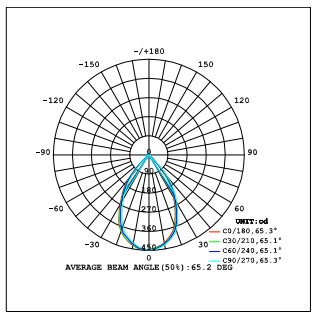

2700K

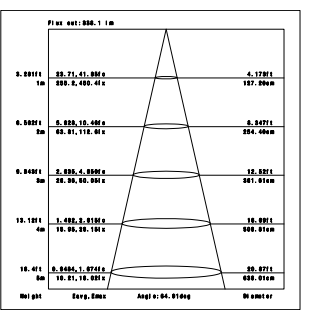

3000K

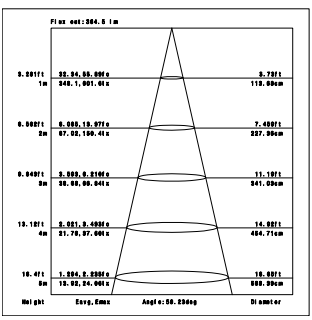

4000K

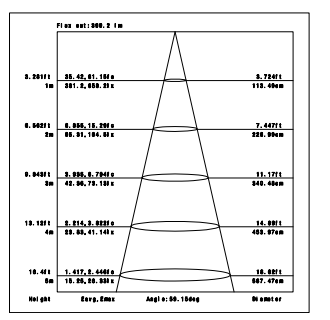

CRI90 16°

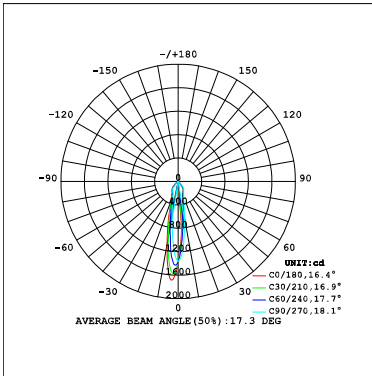

2700K

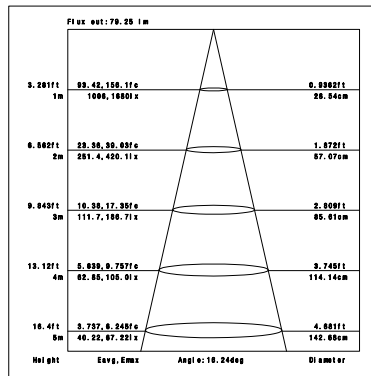

3000K

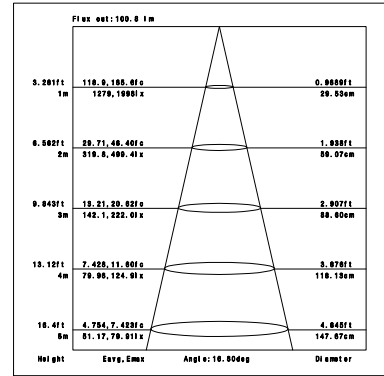

CRI90 28°

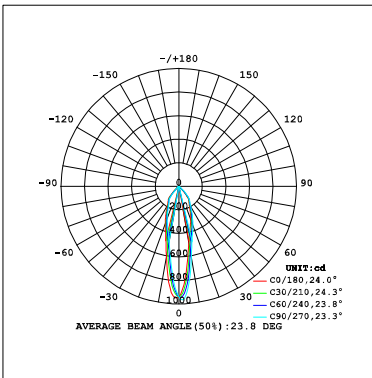

2700K

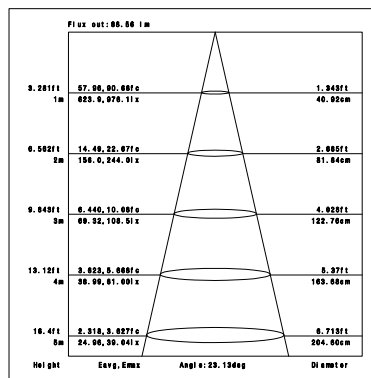

3000K

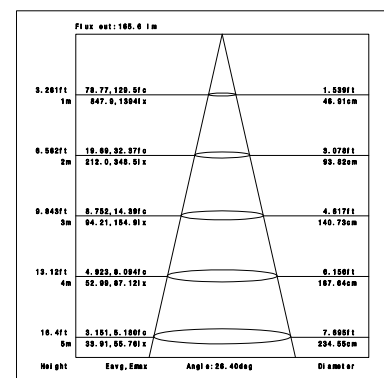

CRI90 40°

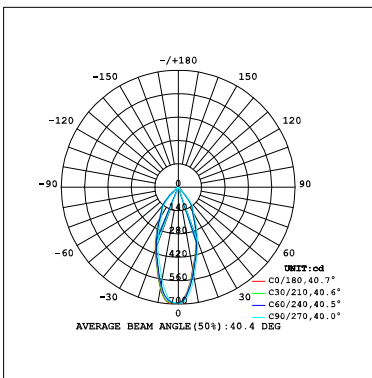

2700K

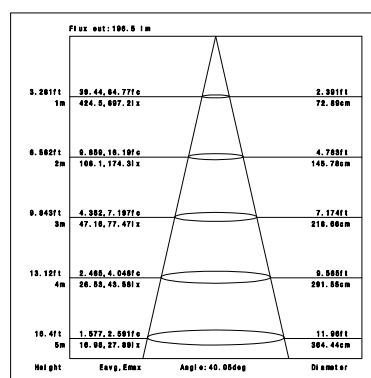

3000K

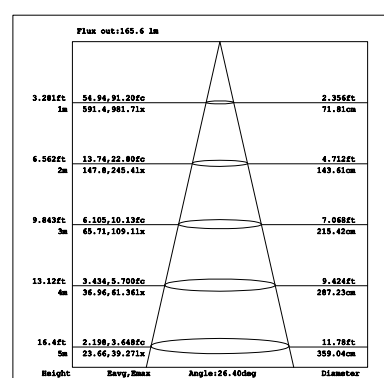

CRI90 60°

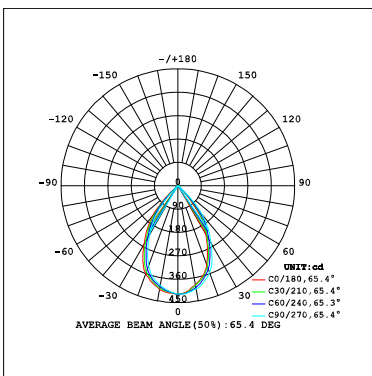

2700K

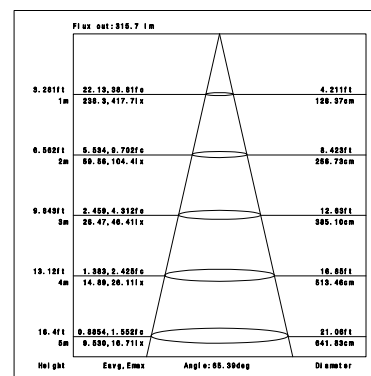

3000K

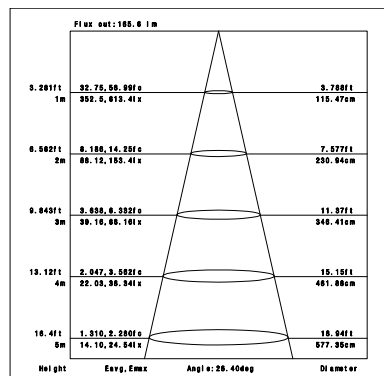

Installation instruction

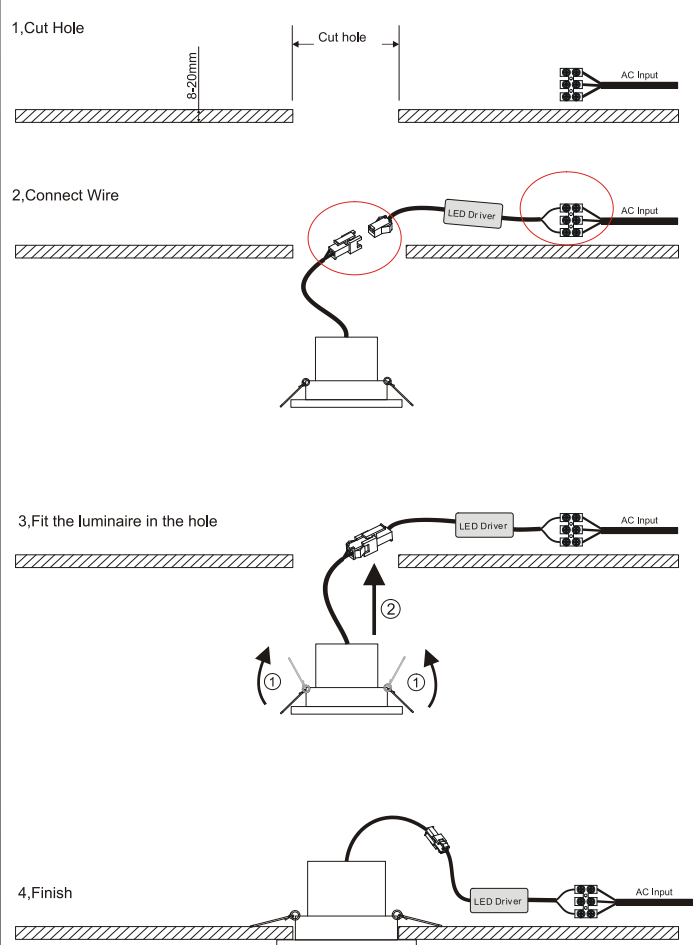
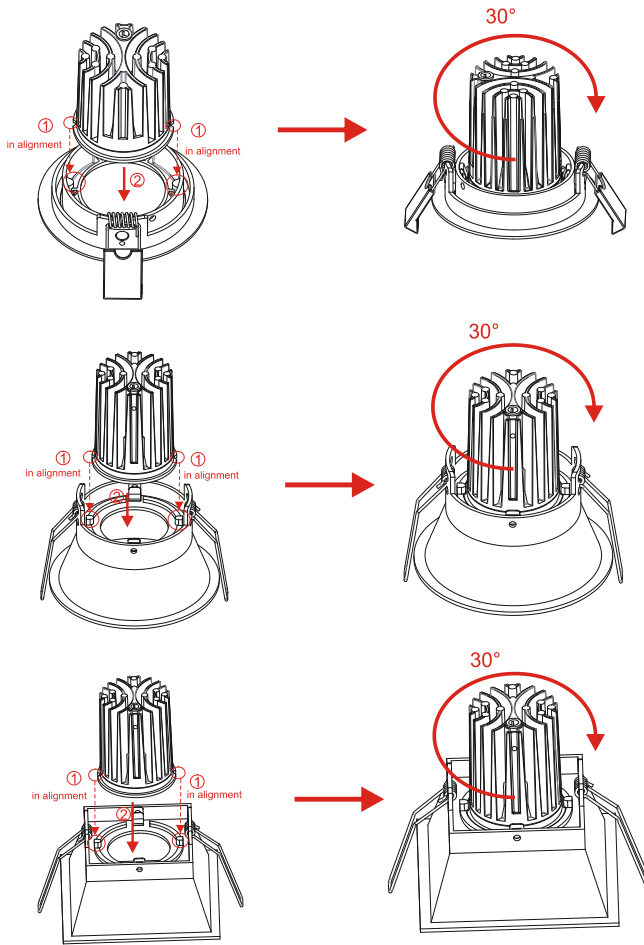

Packaging:

M011 (Without driver)

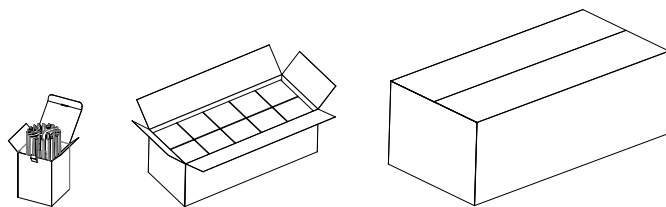

Box L52*W52*H76mm 1pc/box GW: 0.1kg/box	Inner box L270*W110*H95mm 10pc/box GW: 1.05kg/box	Outer carton L600*W300*H230mm 100pcs/CTN GW: 11.5kg/carton
---	---	--

M011 (With driver)

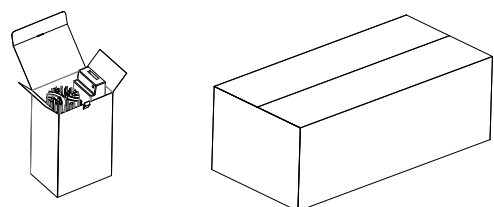

Box L96*W65*H140mm 1pc/box GW: 0.15kg/box	Outer carton L600*W300*H230mm 36pcs/CTN GW: 6.5kg/carton
---	--

M0112

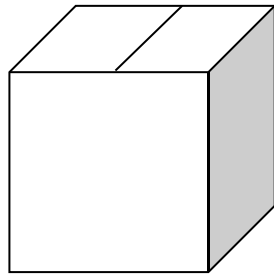
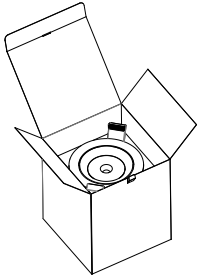

Box
L105*W105*H130mm
1pc/box
GW: 0.25kg/box

Outer carton
L450*W450*H410mm
48pcs/CTN
GW: 14kg/carton

M0113

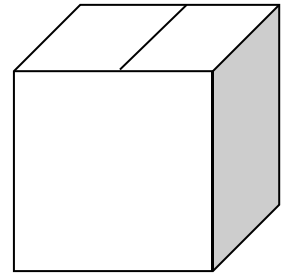
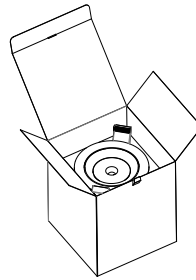

Box
L105*W105*H130mm
1pc/box
GW: 0.3kg/box

Outer carton
L450*W450*H410mm
48pcs/CTN
GW: 16kg/carton

M0114/M0116

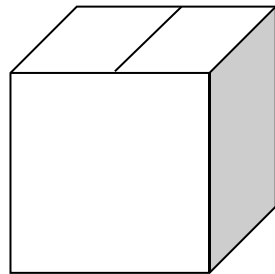
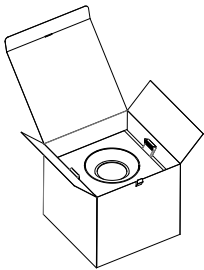

Box
L130*W130*H120mm
1pc/box
GW: 0.35kg/box

Outer carton
L540*W420*H280mm
24pcs/CTN
GW: 9.5kg/carton

M0115

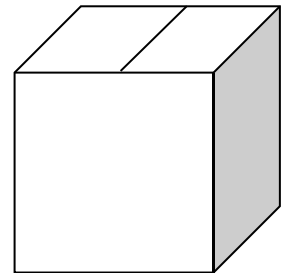
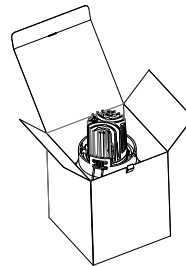

Box
L105*W105*H130mm
1pc/box
GW: 0.35kg/box

Outer carton
L450*W450*H410mm
48pcs/CTN
GW: 18.5kg/carton

Product naming system

M (X) XX X (X) - XW - X XX - X- XX

