

IMSSeries

IMS-GL01 1x20W/2x20W/3X20W

Reflector+Lens

Technical Parameters:

| Name | Parameters | | |
|------------------------------|--------------------|-------|-------|
| Lightsource: | COB | | |
| InputVoltage: | AC220~240V 50/60Hz | | |
| Current:(Adjustable) | 500mA | 500mA | 500mA |
| | 1x20W | 2x20w | 3x20w |
| Ratedlife: | >50,000 hours | | |
| Operatingtemperature: | -20℃~40℃ | | |
| Storage temperature: | -30℃~60℃ | | |
| Certificate: | | | |
| Dimmability: | DimmableOptional | | |

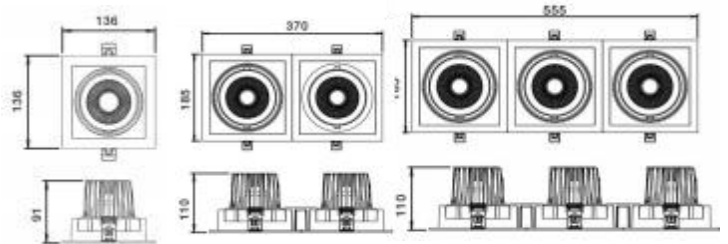
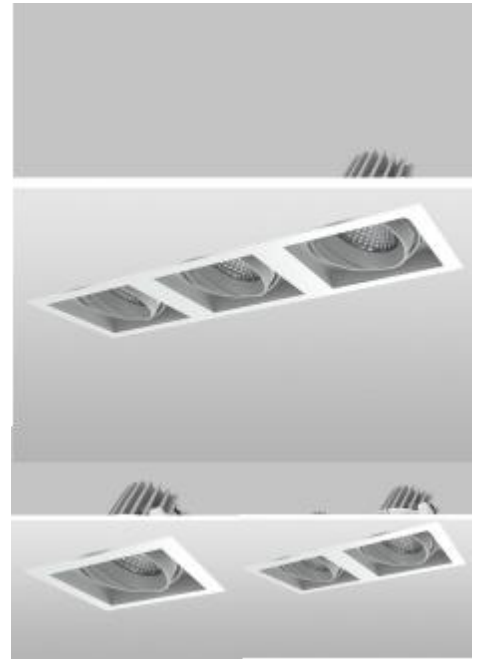

Ordering Information:

● Silvergray

| Power | CRI | BeamAngle | Luminous | CCT | Housing | PartNumber |
|-------|-----|-----------|----------|-------|---------|-------------------------|
| 1x20W | 80 | ▲ 15° | 2180 lm | 3000K | ● | IMS-GL0111-20W-830-S-15 |
| | | | 2190 lm | 4000K | ● | IMS-GL0111-20W-840-S-15 |
| | | ▲ 28° | 2180 lm | 3000K | ● | IMS-GL0111-20W-830-S-28 |
| | | | lm lm | 4000K | ● | IMS-GL0111-20W-840-S-28 |
| | | ▲ 36° | 2185 lm | 3000K | ● | IMS-GL0111-20W-830-S-36 |
| | | | 2192 lm | 4000K | ● | IMS-GL0111-20W-840-S-36 |
| | >90 | ▲ 15° | 1805 lm | 3000K | ● | IMS-GL0111-20W-930-S-15 |
| | | | 1795 lm | 3000K | ● | IMS-GL0111-20W-930-S-28 |
| | | ▲ 28° | 1798 lm | 3000K | ● | IMS-GL0111-20W-930-S-36 |
| | | | 1798 lm | 3000K | ● | IMS-GL0111-20W-930-S-36 |
| | | ▲ 36° | 1798 lm | 3000K | ● | IMS-GL0111-20W-930-S-36 |
| | | | 1798 lm | 3000K | ● | IMS-GL0111-20W-930-S-36 |
| 2x20W | >80 | ▲ 15° | 3491lm | 3000K | ● | IMS-GL0121-20W-830-S-15 |
| | | | 3495 lm | 4000K | ● | IMSGLO121-20W-840-S-15 |
| | | ▲ 28° | 3490 lm | 3000K | ● | IMS-GL0121-20W-830-S-28 |
| | | | 3480 lm | 4000K | ● | IMS-GL0121-20W-840-S-28 |
| | | ▲ 36° | 3495 lm | 3000K | ● | IMS-GL0121-20W-830-S-36 |
| | | | 3475lm | 4000K | ● | IMS-GL0121-20W-840-S-36 |
| | >90 | ▲ 15° | 3890 lm | 3000K | ● | IMS-GL0121-20W-930-S-15 |
| | | | 3870 lm | 3000K | ● | IMS-GL0121-20W-930-S-28 |
| | | ▲ 28° | 3870 lm | 3000K | ● | IMS-GL0121-20W-930-S-28 |
| | | | 3870 lm | 3000K | ● | IMS-GL0121-20W-930-S-28 |
| | | ▲ 36° | 2875 lm | 3000K | ● | IMS-GL0121-20W-930-S-36 |
| | | | 2875 lm | 3000K | ● | IMS-GL0121-20W-930-S-36 |



Technical Data test pattern

20W CRI80 15°

3000K

4000K

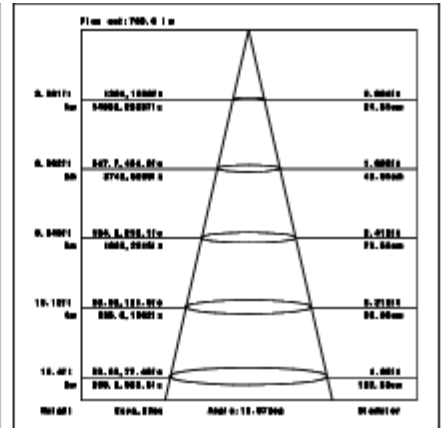
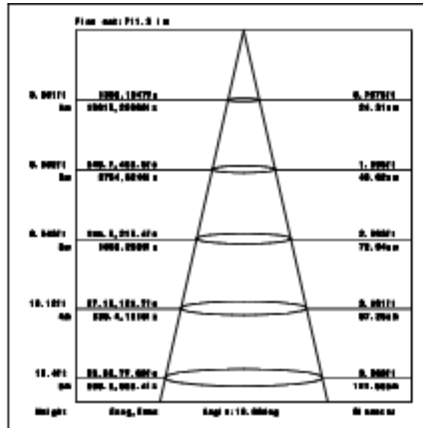
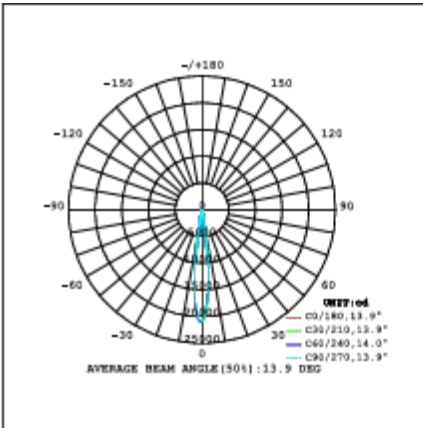

20W CRI80 28°

3000K

4000K

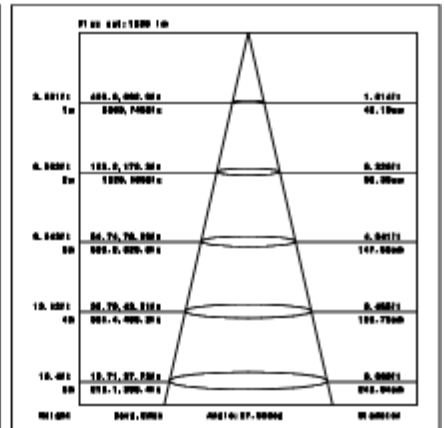
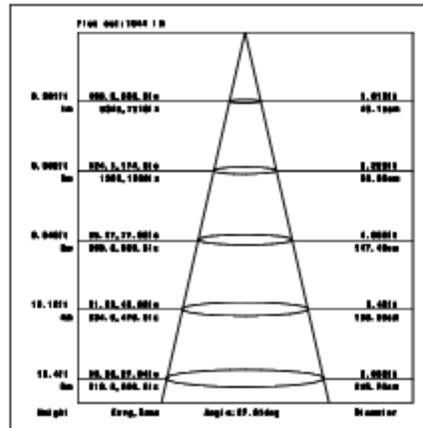
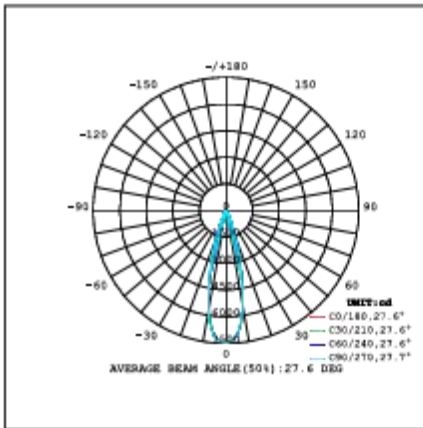

20W CRI80 36°

3000K

4000K

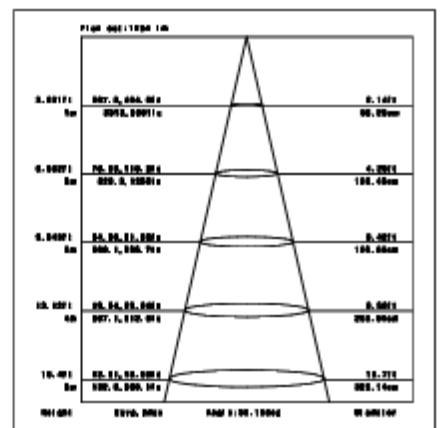
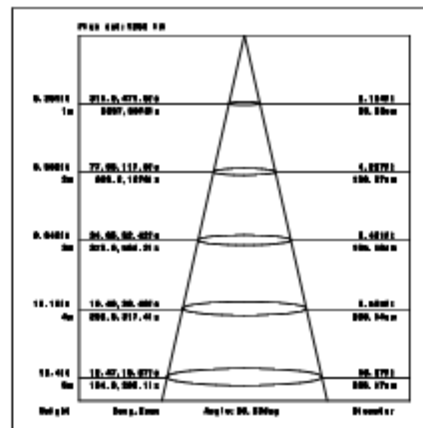
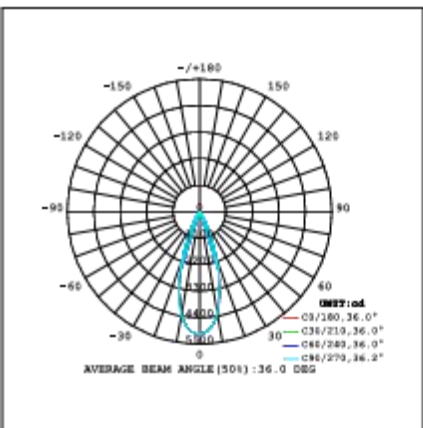

20W CRI90 15°

3000K

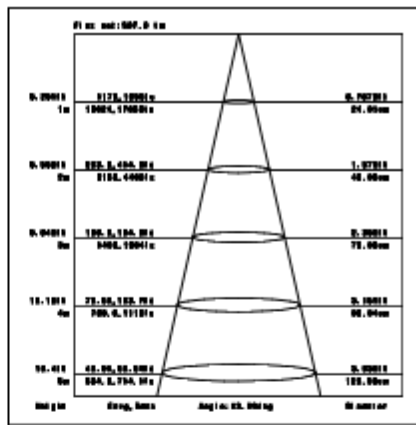
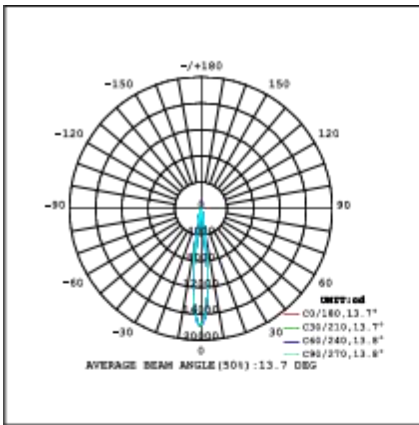

20W CRI90 28°

3000K

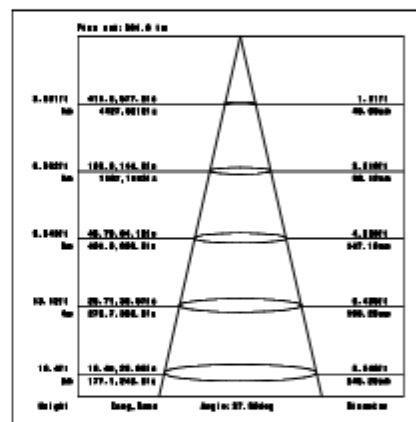
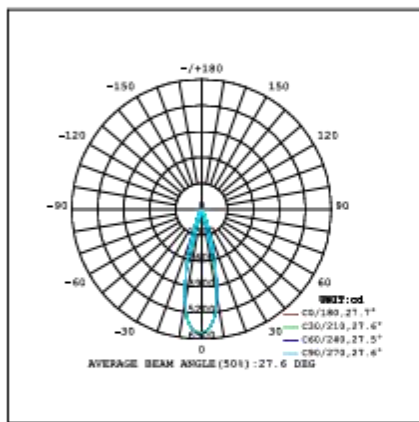

20W CRI90 36°

3000K

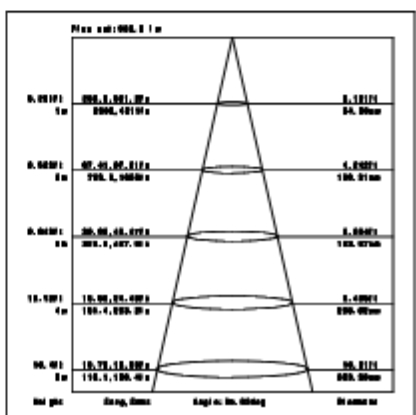
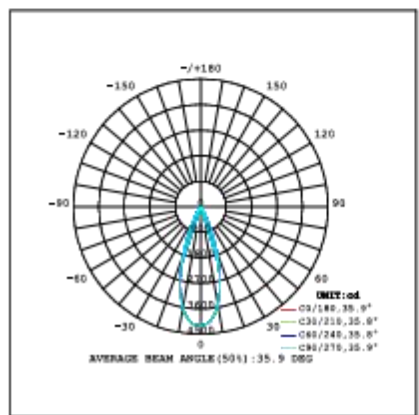

Installation instruction

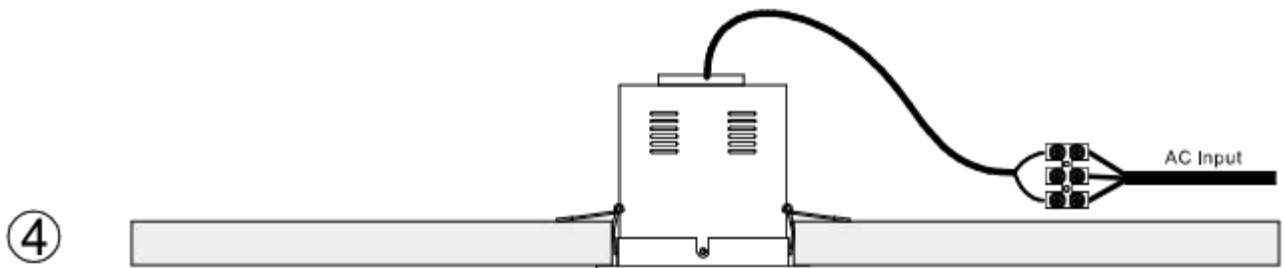
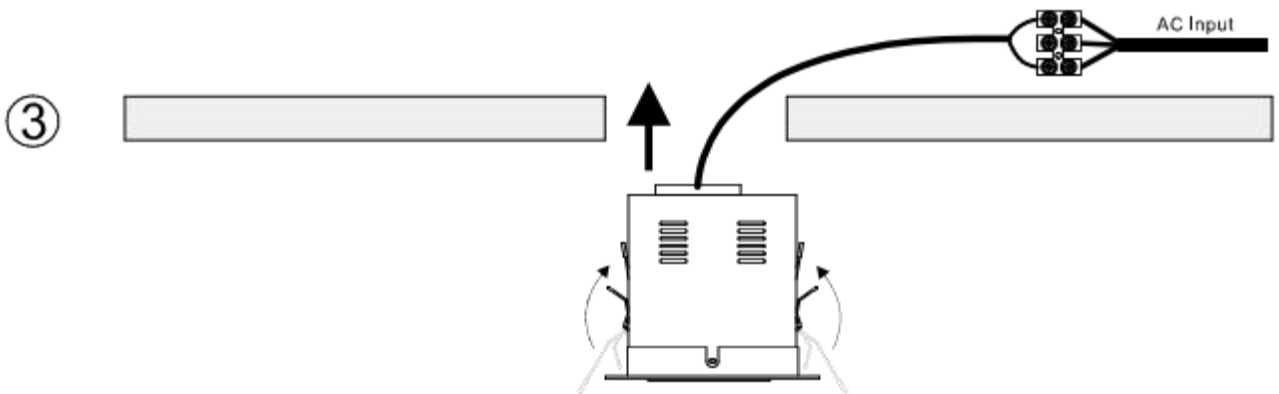
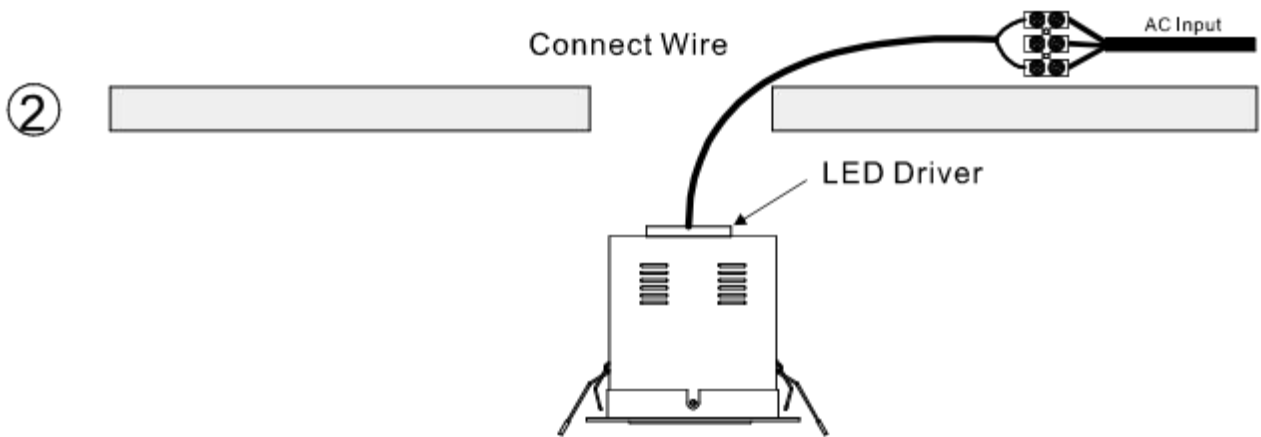

Packaging:

IMS-GL0111(Without driver)

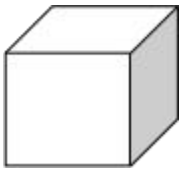

Box
L170*W170*H160mm
1pc/box
GW: 0.9kg/box

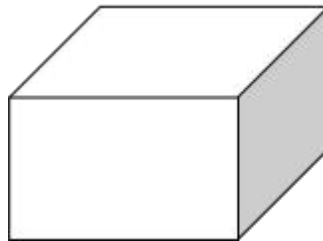

Outer carton
L700*W355*H385mm
16pcs/CTN
GW: 15.5kg/carton

IMS-GL0121(Without driver)

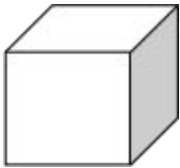

Box
L230*W140*H280mm
1pc/box
GW: 1.75kg/box

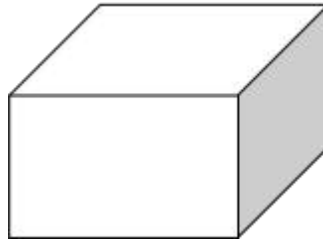

Outer carton
L720*W295*H280mm
6pcs/CTN
GW: 11.5kg/carton

IMS-GL0131(Without driver)

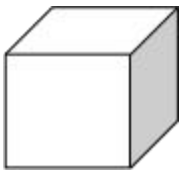

Box
L340*W140*H130mm
1pc/box
GW: 2.7kg/box

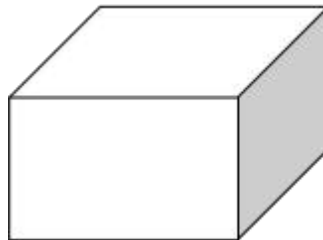

Outer carton
L720*W295*H280mm
8pcs/CTN
GW: 22.6kg/carton

Product naming system

DL (X) XX X (H) – XW – X XX – X- XX

