

FLOW.IT Series

DL34-M-20W

optical lens

Technical Parameters:

Name	Parameters
Light source:	COB
Input Voltage:	AC220~240V 50/60Hz
LED Current:	500mA, 35-37V
Beam Angle:	15°/20°/36°/48°/60°
Life Time:	> 50,000h - L80 - B10 (Ta 25° C)
Operating temperature:	-20°C~40°C
Certificate:	CE/RoHS
Weight:	0.45kg

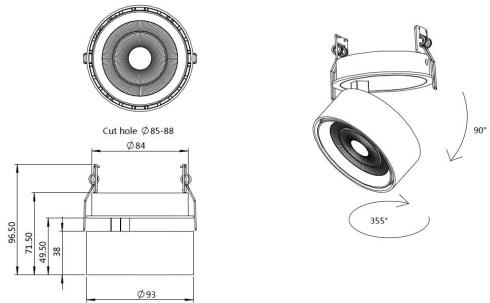

Ordering Information:

○White ●Black

Power	CRI	Beam Angle	Luminous	CCT	Housing	Part Number
20W	>80	▲ 15°	1910 lm	3000K	○	DL341-20W-830-W-15-M
			2102 lm	4000K	●	DL341-20W-830-B-15-M
		▲ 20°	1778 lm	3000K	○	DL341-20W-830-W-20-M
			1962 lm	4000K	●	DL341-20W-830-B-20-M
		▲ 36°	1870 lm	3000K	○	DL341-20W-830-W-36-M
			2086 lm	4000K	●	DL341-20W-830-B-36-M
	>90	▲ 12°	1566 lm	3000K	○	DL341-20W-930-W-15-M
			1766 lm	3000K	●	DL341-20W-930-B-15-M
		▲ 20°	1766 lm	3000K	○	DL341-20W-930-W-20-M
			1672 lm	3000K	●	DL341-20W-930-B-20-M
		▲ 36°	1672 lm	3000K	○	DL341-20W-930-W-36-M
					●	DL341-20W-930-B-36-M

Technical Data test pattern

CRI80 15°

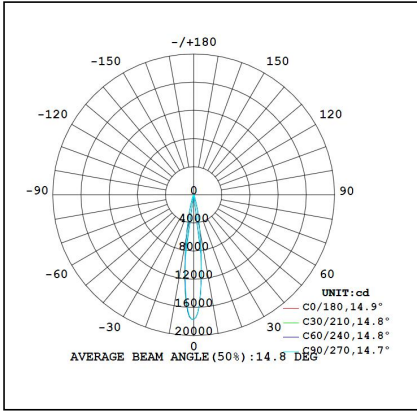

3000K

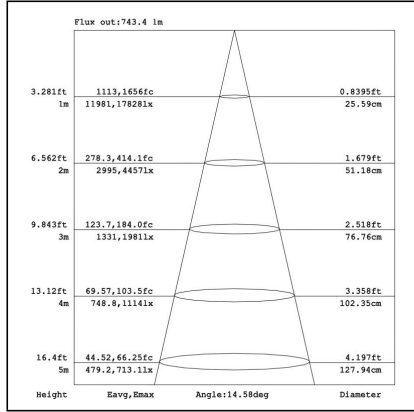

4000K

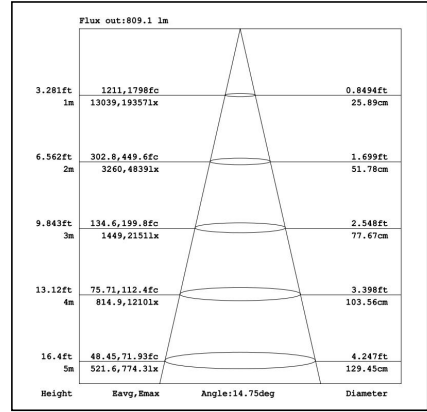

CRI80 20°

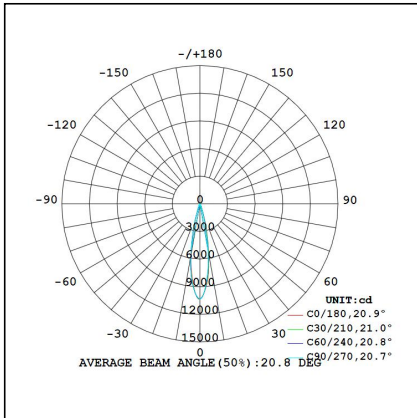

3000K

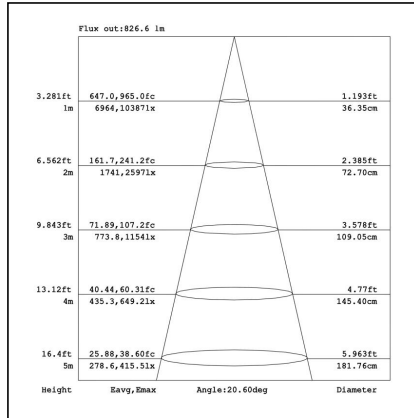

4000K

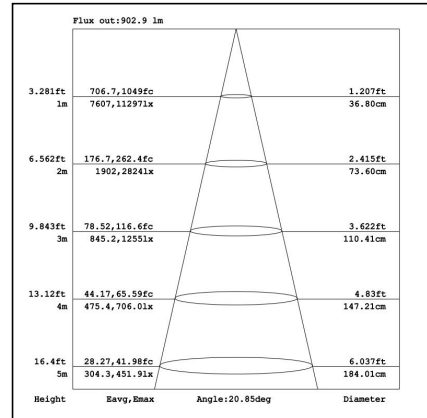

CRI80 36°

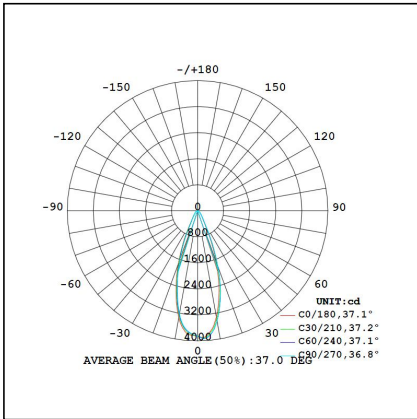

3000K

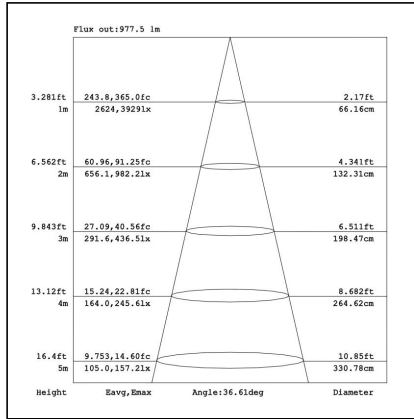

4000K

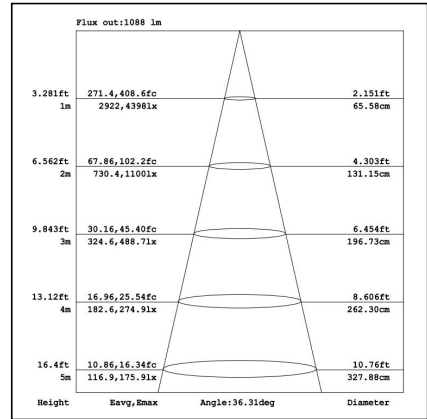

CRI80 48°

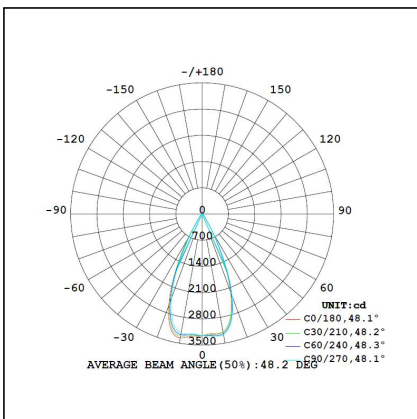

3000K

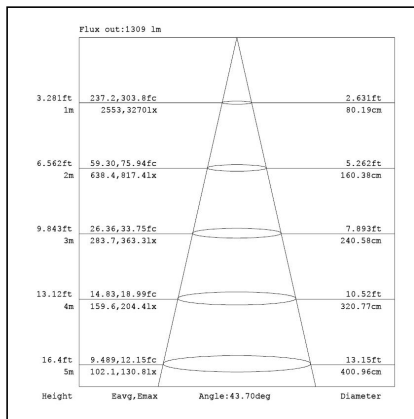

4000K

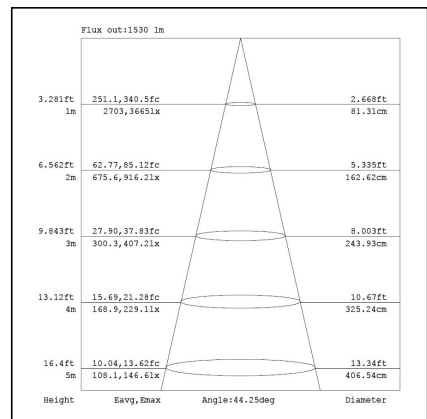

CRI80 60°

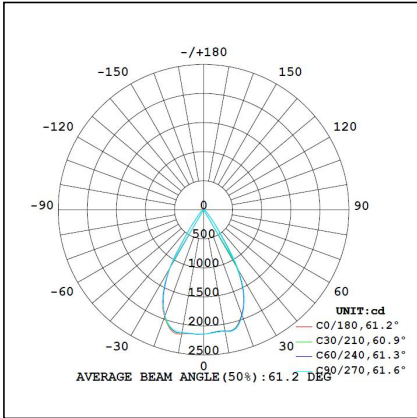

3000K

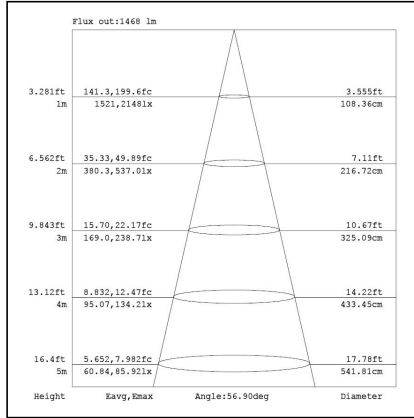

4000K

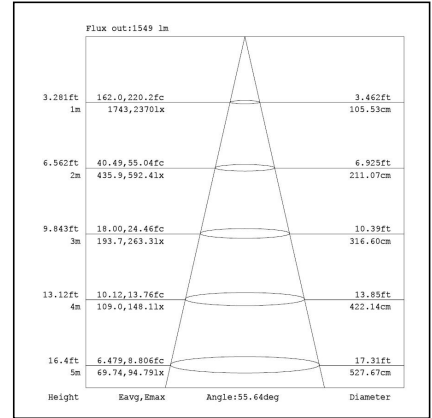

CRI90 15°

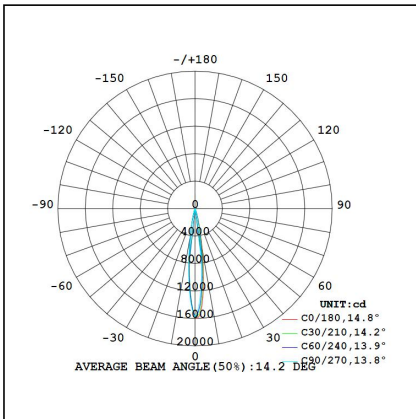

3000K

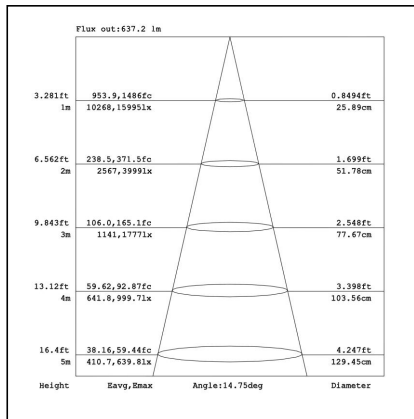

4000K

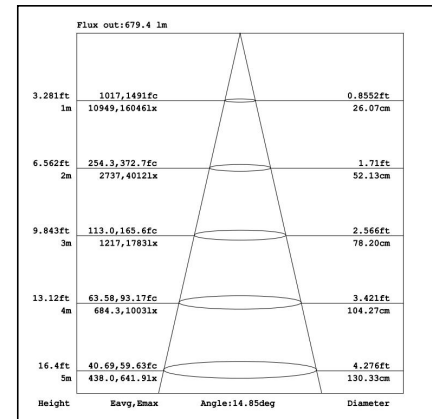

CRI90 20°

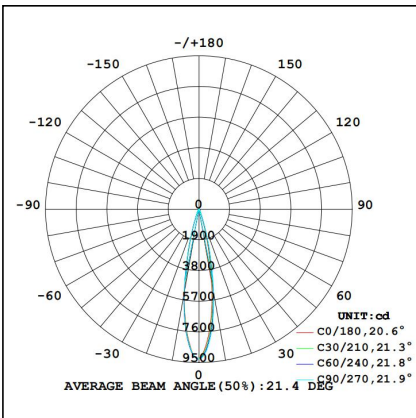

3000K

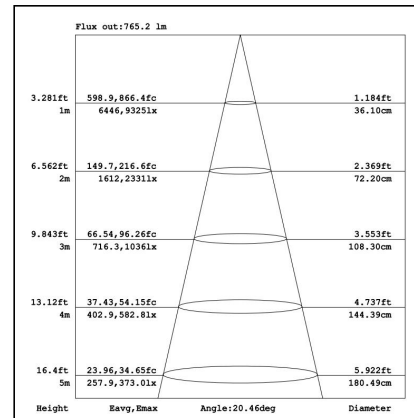

4000K

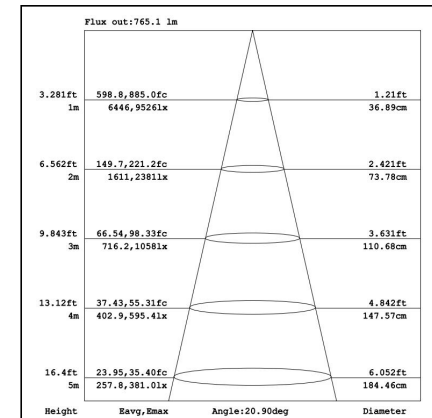

CRI90 36°

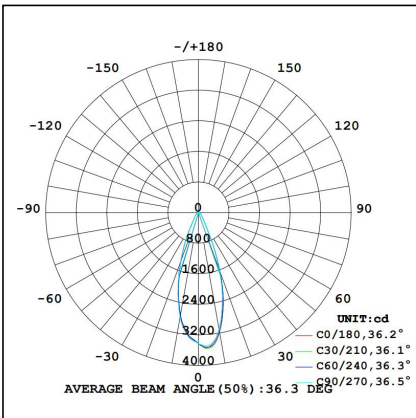

3000K

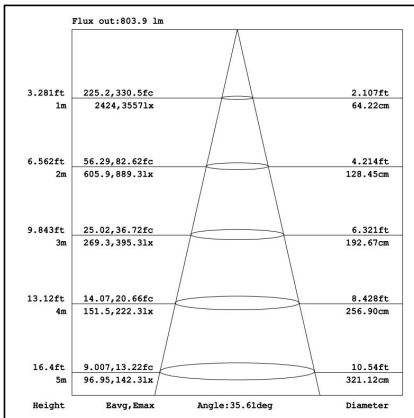

4000K

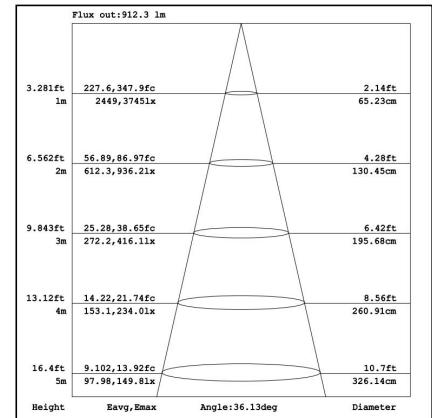

Installation instruction

1, Cut Hole

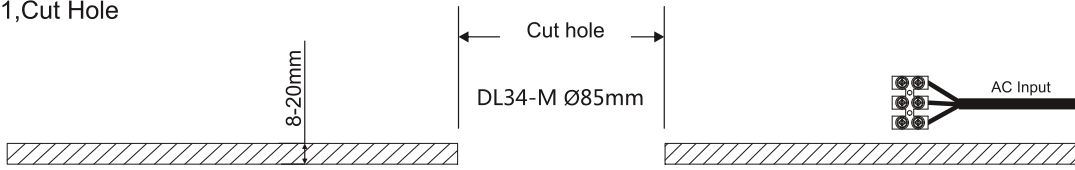

2, Connect Wire

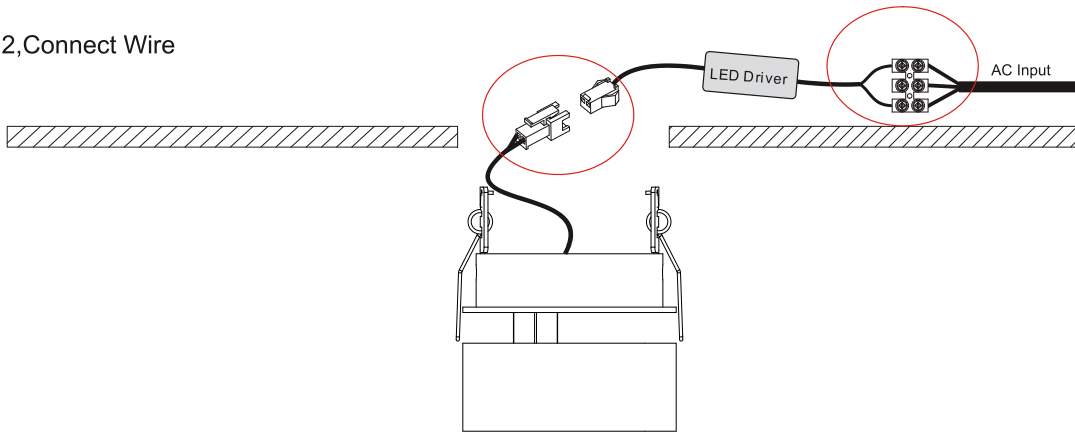

3, Fit the luminaire in the hole

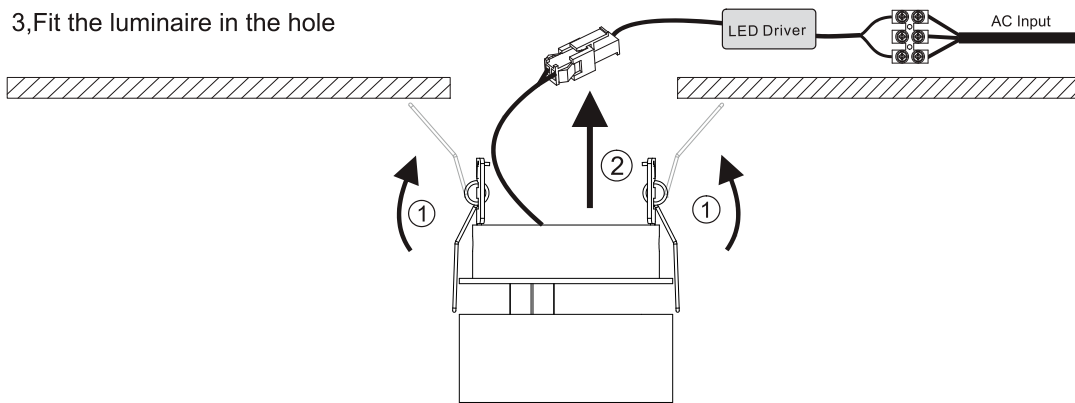

4, Finish

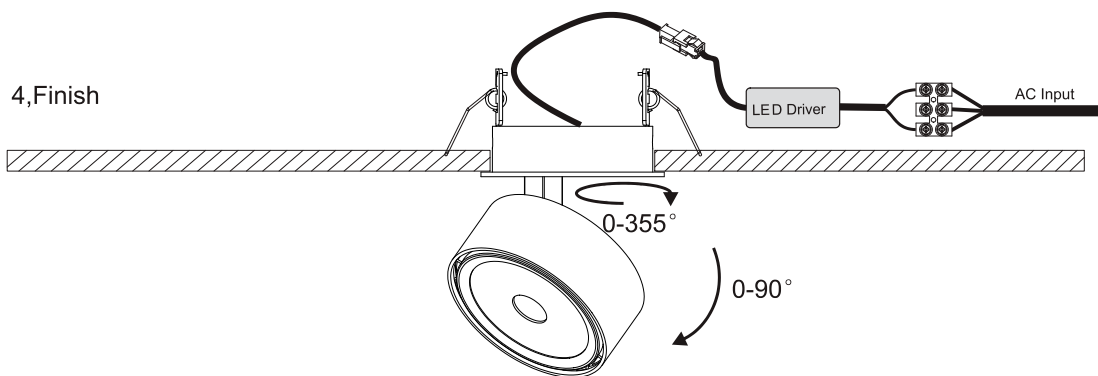

Packaging:

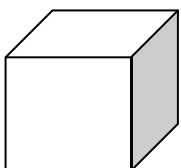

Box
 L105*W105*H125mm
 1pc/box
 GW: 0.55kg/box

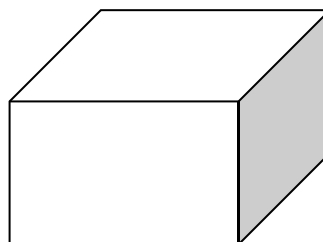

Outer carton
 L430*W430*H300mm
 32pcs/CTN
 GW: 18.5kg/carton