

veraLite Series

**DL25-28W**

Reflector



Technical Parameters:

Name	Parameters
Light source:	COB
Input Voltage:	AC220~240V 50/60Hz
LED Current:	700mA (35-37V)
Rated life:	>50,000 hours
Operating temperature:	-20°C~40°C
Storage temperature:	-30°C~60°C
Certificate:	TUV/CE/RoHS
Dimmability:	Dimmable Optional
Weight:	0.8KG

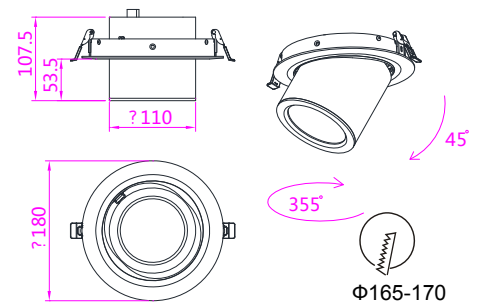

Ordering Information:

○ White

Power	CRI	Beam Angle	Luminous	CCT	Housing	Part Number
28W	>80	▲ 15°	2980 lm	3000K	○	DL251-28W-830-W-15
			3160 lm	4000K	○	DL251-28W-840-W-15
		▲ 20°	3010 lm	3000K	○	DL251-28W-830-W-20
			3250 lm	4000K	○	DL251-28W-840-W-20
		▲ 45°	2990 lm	3000K	○	DL251-28W-830-W-45
			3190 lm	4000K	○	DL251-28W-840-W-45
	>90	▲ 15°	2670 lm	3000K	○	DL251-28W-930-W-15
			2810 lm	4000K	○	DL251-28W-940-W-15
		▲ 20°	2700 lm	3000K	○	DL251-28W-930-W-20
			2820 lm	4000K	○	DL251-28W-940-W-20
		▲ 45°	2680 lm	3000K	○	DL251-28W-930-W-45
			2810 lm	4000K	○	DL251-28W-940-W-45

Technical Data test pattern

CRI80 15°

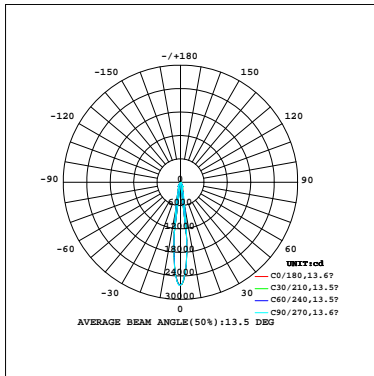

3000K

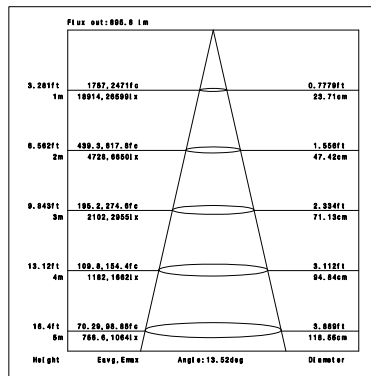

4000K

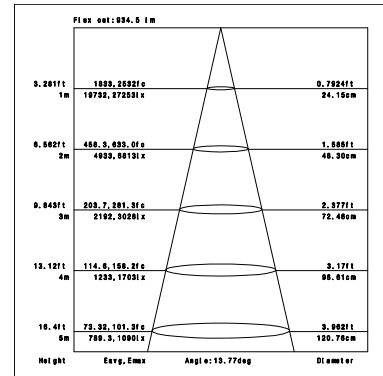

CRI80 20°

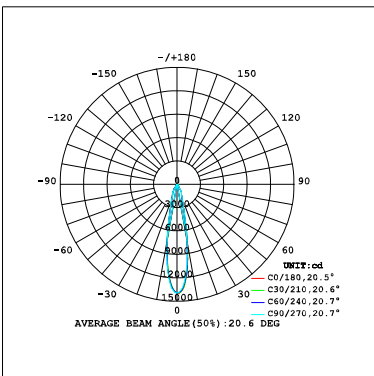

3000K

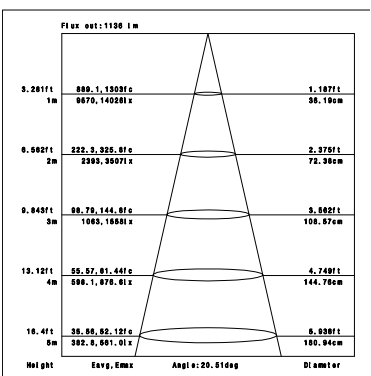

4000K

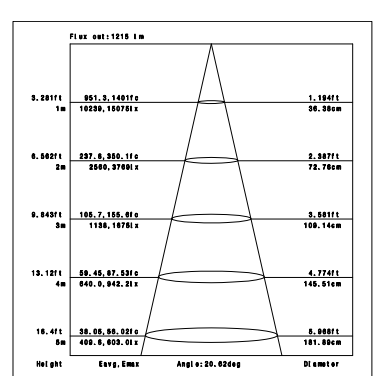

CRI80 45°

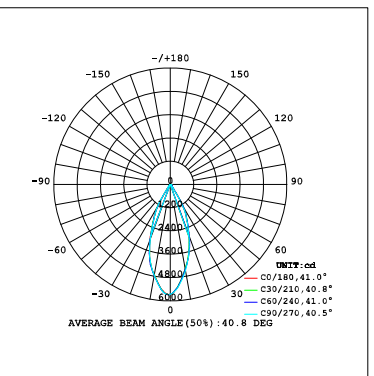

3000K

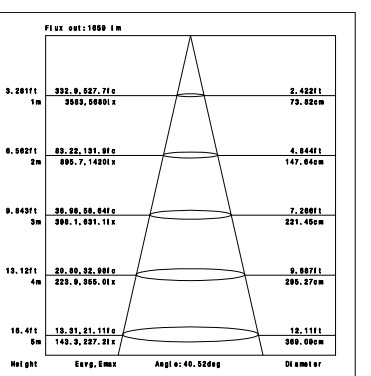

4000K

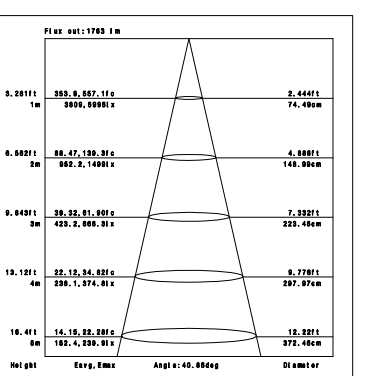

CRI90 15°

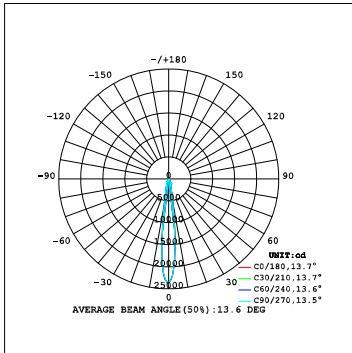

3000K

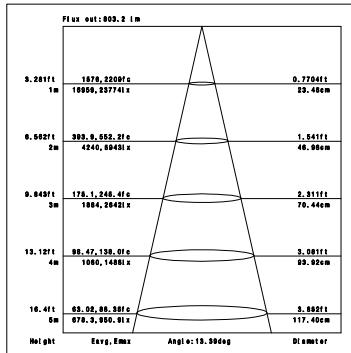

4000K

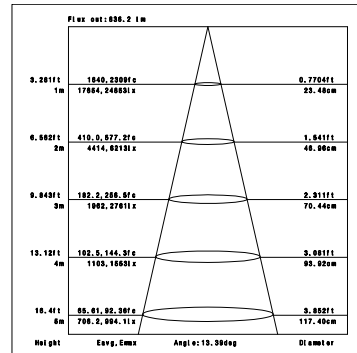

CRI90 20°

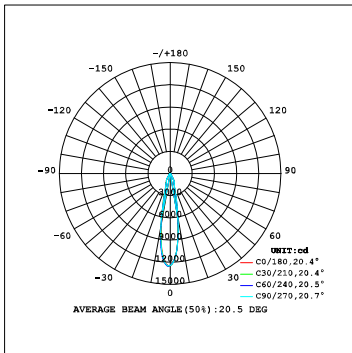

3000K

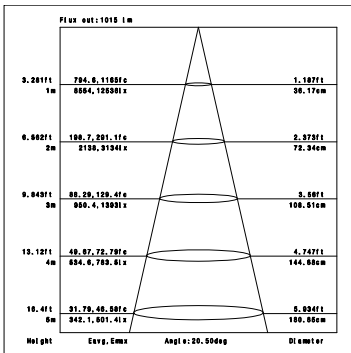

4000K

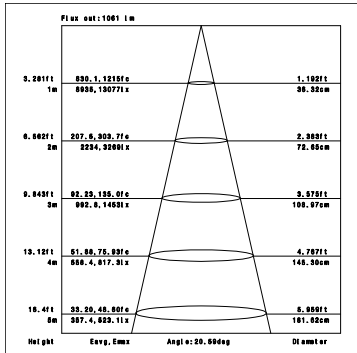

CRI90 45°

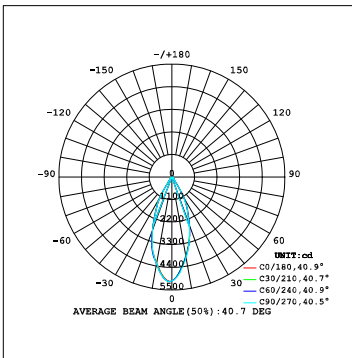

3000K

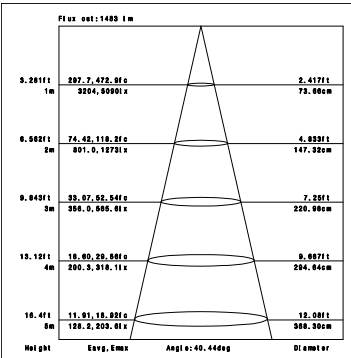

4000K

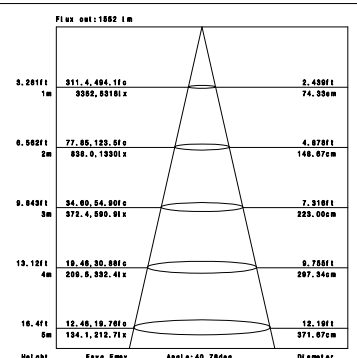

Packaging:

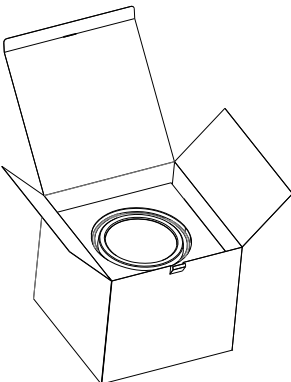

Box  
L210\*W210\*H170mm  
1pc/box  
GW: 1.0kg/box

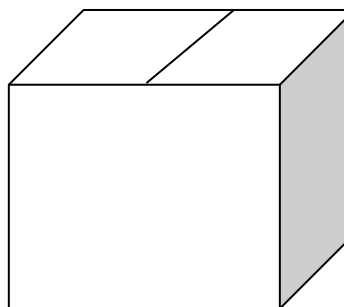

Outer carton  
L430xW430xH350mm  
8pcs/CTN  
GW: 8.5kg/carton

Installation instruction

1, Cut Hole

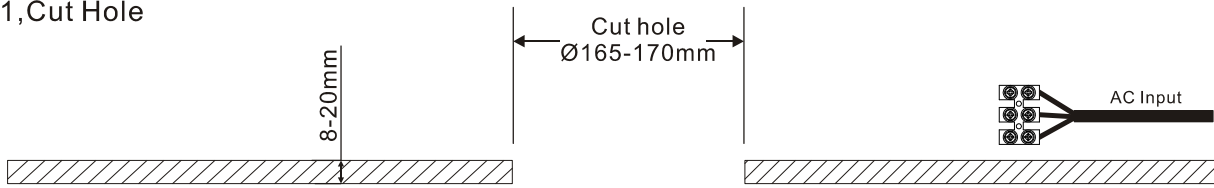

2, Connect Wire

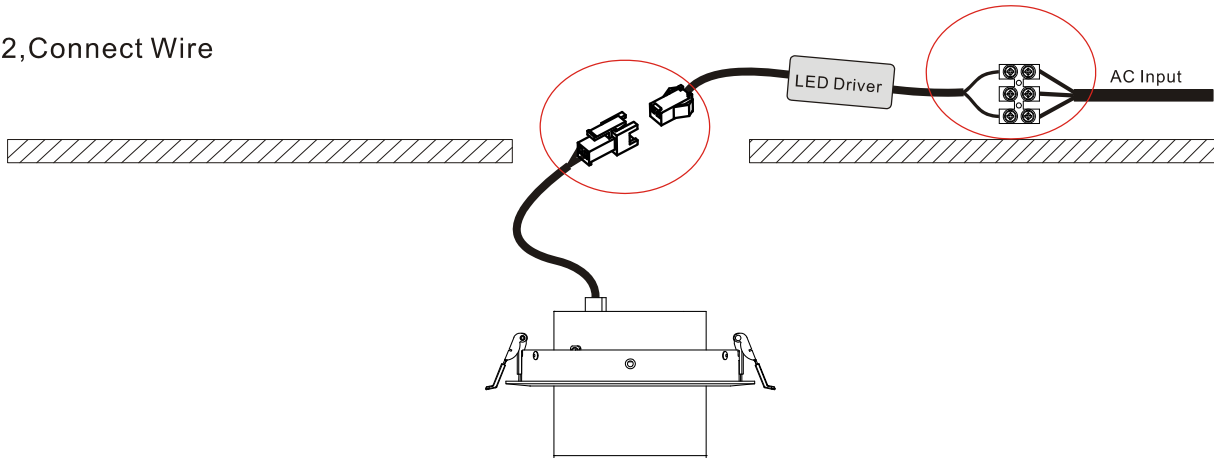

3, Fit the luminaire in the hole

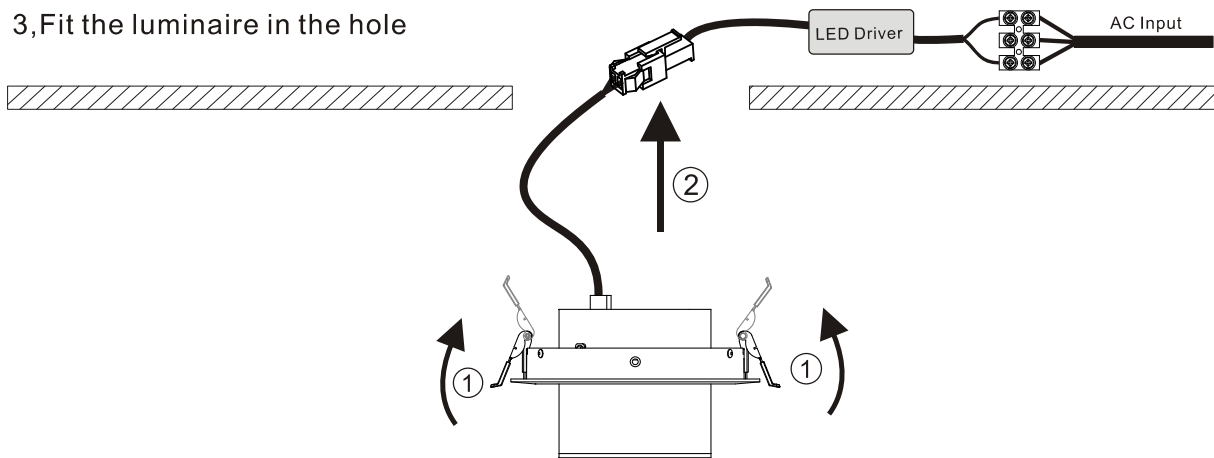

4, Finish

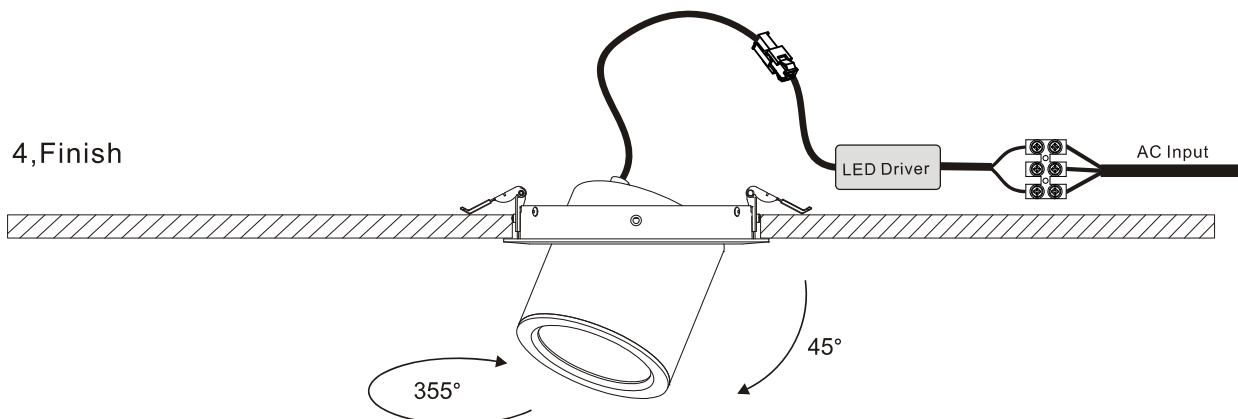

Product naming system

**DL ( X ) XX X (H) – XW – X XX – X- XX**

