

iTrack Pro Series

**DBA-TL29-16W**

optical lens



Technical Parameters:

Name	Parameters
Light source:	COB
Input Voltage:	AC220~240V 50/60Hz
LED Current:	400mA, 34-36V
Rated life:	>50,000 hours
Operating temperature:	-20°C~40°C
Storage temperature:	-30°C~60°C
Certificate:	CE/RoHS
Weight:	0.8KG

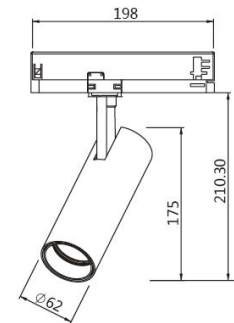

Ordering Information:

○ White ● Black

Power	CRI	Beam Angle	Luminous	CCT	Housing	Part Number
16W	>80	▲ 15°	1590 lm	3000K	○	DBA-TL294-16W-830-W-15
					●	DBA-TL294-16W-830-B-15
		▲ 25°	1795 lm	3000K	○	DBA-TL294-16W-830-W-25
					●	DBA-TL294-16W-830-B-25
		▲ 38°	1815 lm	3000K	○	DBA-TL294-16W-830-W-38
					●	DBA-TL294-16W-830-B-38
	>90	▲ 15°	1370 lm	3000K	○	DBA-TL294-16W-930-W-15
					●	DBA-TL294-16W-930-B-15
			1450 lm	4000K	○	DBA-TL294-16W-940-W-15
					●	DBA-TL294-16W-940-B-15
		▲ 25°	1510 lm	3000K	○	DBA-TL294-16W-930-W-25
					●	DBA-TL294-16W-930-B-25
	1607 lm	4000K	○	DBA-TL294-16W-940-W-25		
			●	DBA-TL294-16W-940-B-25		
	▲ 38°	1517 lm	3000K	○	DBA-TL294-16W-930-W-38	
				●	DBA-TL294-16W-930-B-38	
		1755 lm	4000K	○	DBA-TL294-16W-940-W-38	
				●	DBA-TL294-16W-940-B-38	

Technical Data test pattern

CRI80 15°

3000K

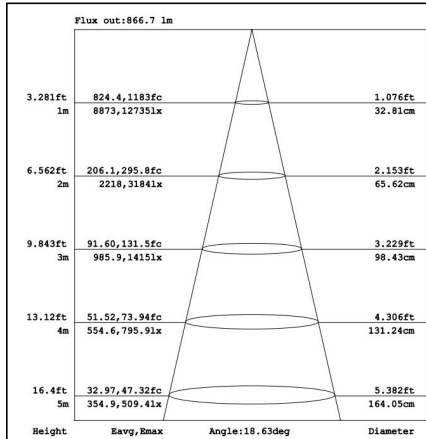
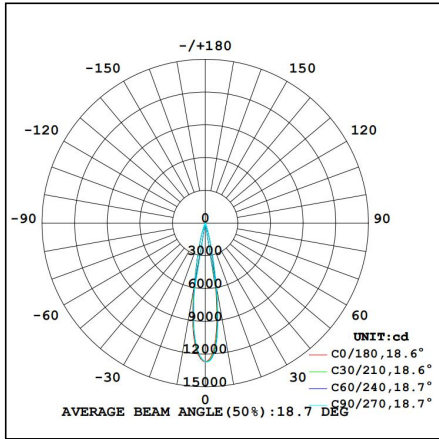

CRI80 25°

3000K

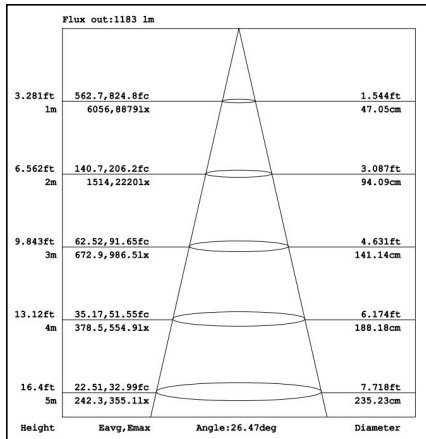
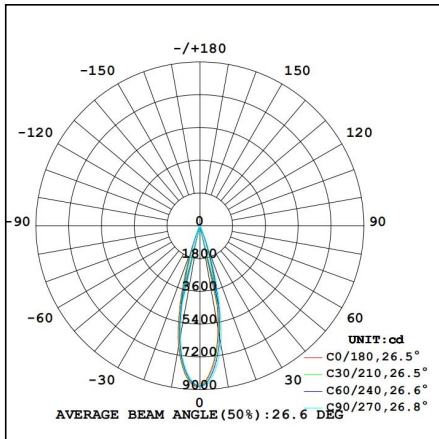

CRI80 38°

3000K

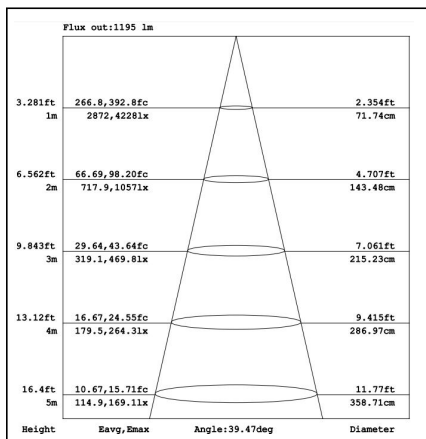
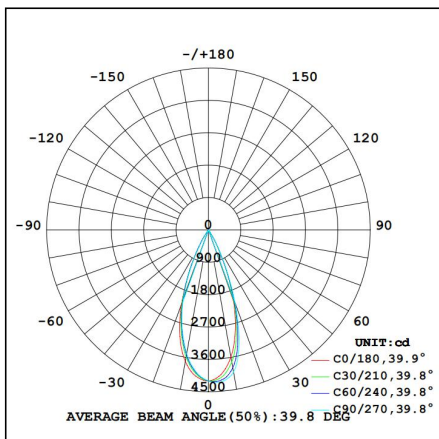

CRI90 15°

3000K

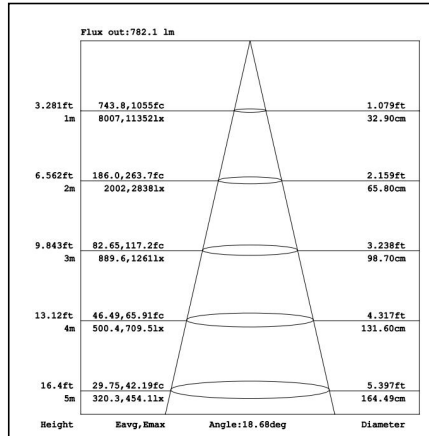
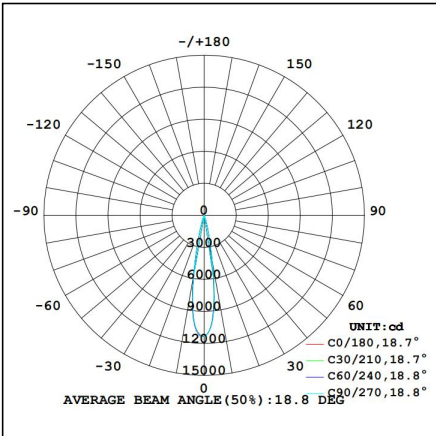

CRI90 25°

3000K

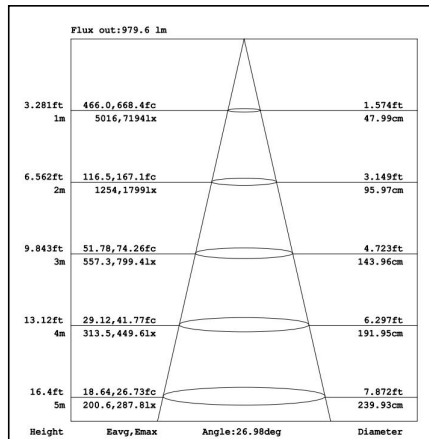
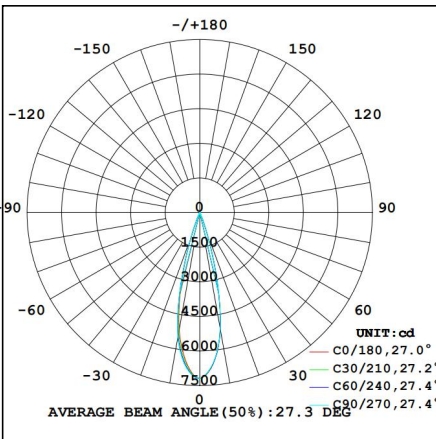

CRI90 38°

3000K

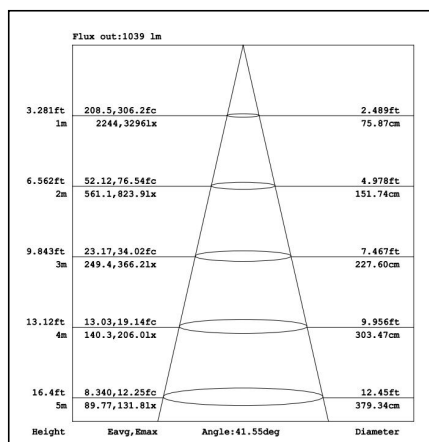
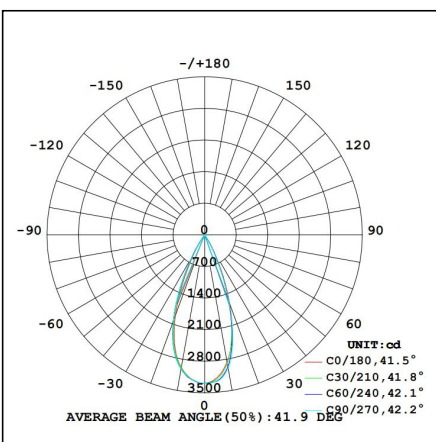

# Installation Instructions

DESCRIPTION: 3 Circuit Track Spot

## NOTICE

1. This fitting requires 220-240V AC/50HZ power input to the driver.
2. Do not interchange any parts of this fitting.
3. A minimum distance of 75mm is required around the fitting to allow for air ventilation.
4. Allow a minimum distance between fitting and illuminated subject of 800mm.
5. Do not touch fitting when in use.
6. Do not cover with any form of heat proof material.
7. If you have any questions about the installation of this product, please contact us.

## INSTALLATION PROCESS

1. Ensure the mains power is turned off.
2. Check that adapter orientation is correct.
3. Press adapter against track.
4. Turn locking lever to lock adapter to track.
5. Power switch adjust to "●OFF" position and then rotate to select circuit to "1→off→3→off→2" or "2←off←3←off←1".
6. Installation is complete.

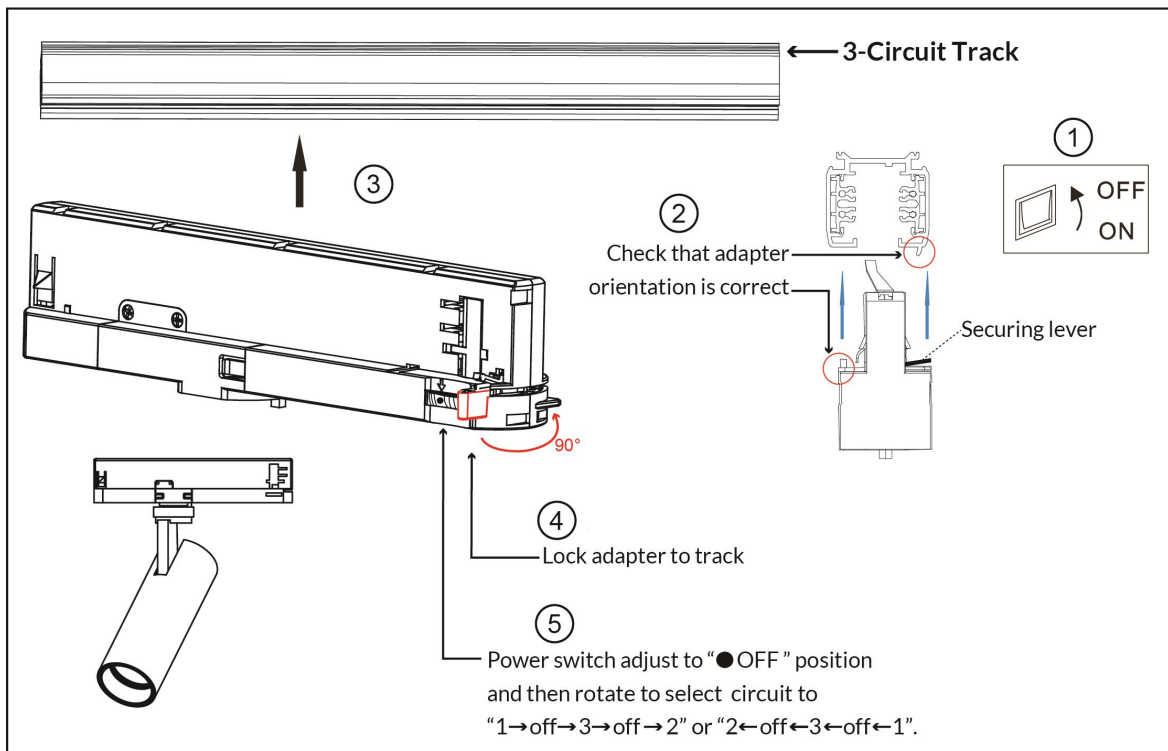
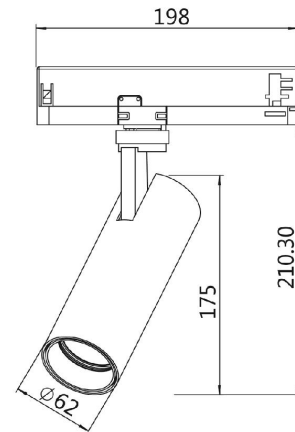

Packaging:

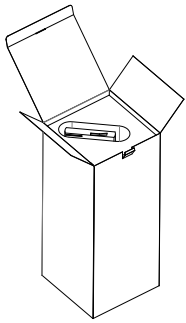

**Box**  
 L250\*W110H250mm  
 1pc/box  
 GW: 1.13kg/box

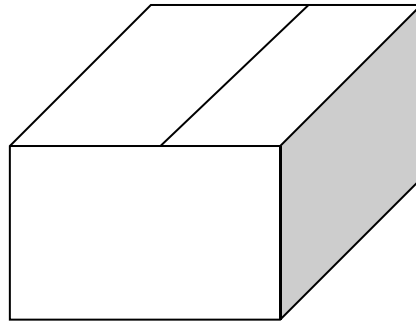

**Outer carton**  
 L565xW515xH515mm  
 20pcs/CTN  
 GW: 22.5kg/carton

Product naming system

**TL ( X ) XX X ( H ) – XW – X XX – X- XX**

