

# BL17 Installation Instruction

## 1, Cut Hole

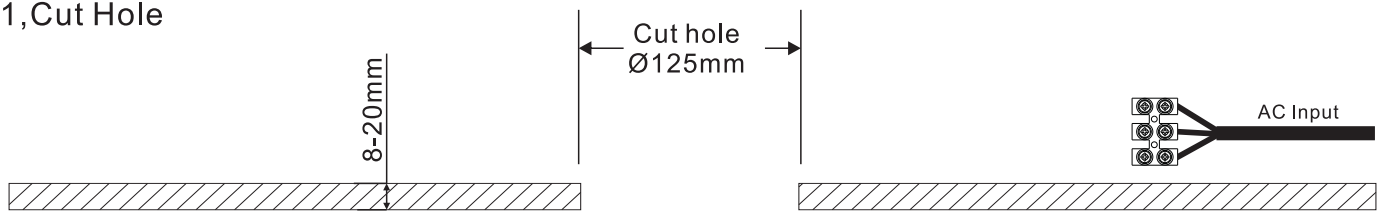

## 2, Connect Wire

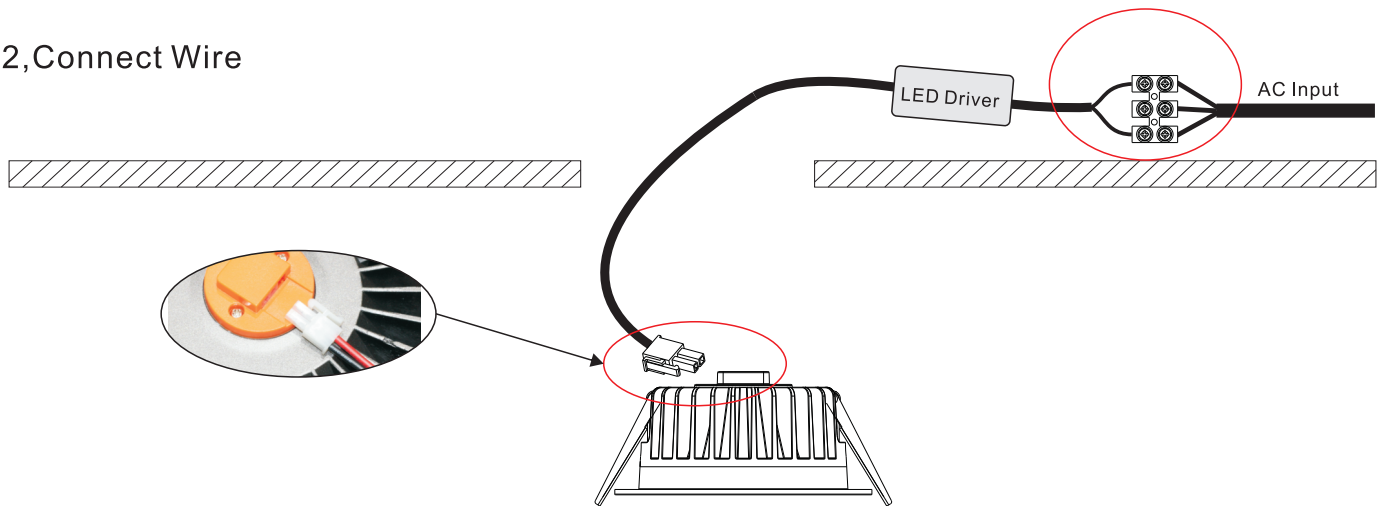

## 3, Fit the luminaire in the hole

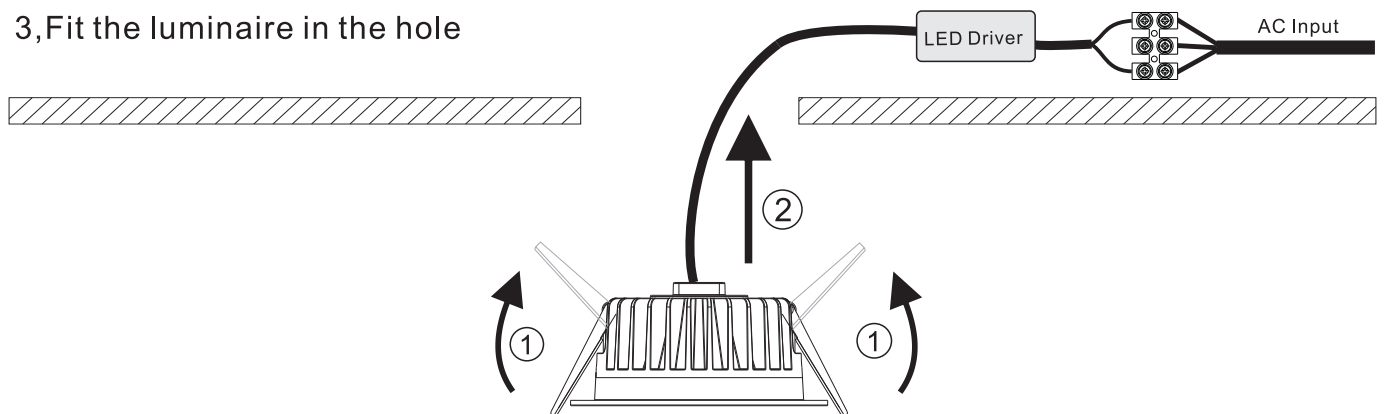

## 4, Finish

