

Combination Instructions of GL12 Grille downlight:

1, Materials list.

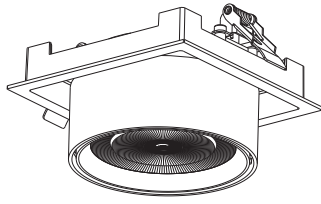

GL12 lamp

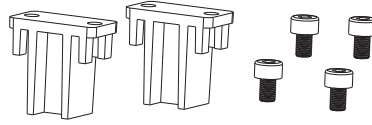

Connection sets(2pcs a set)
Screw M4X8(4pcs a set)

2,Combination Process

2X

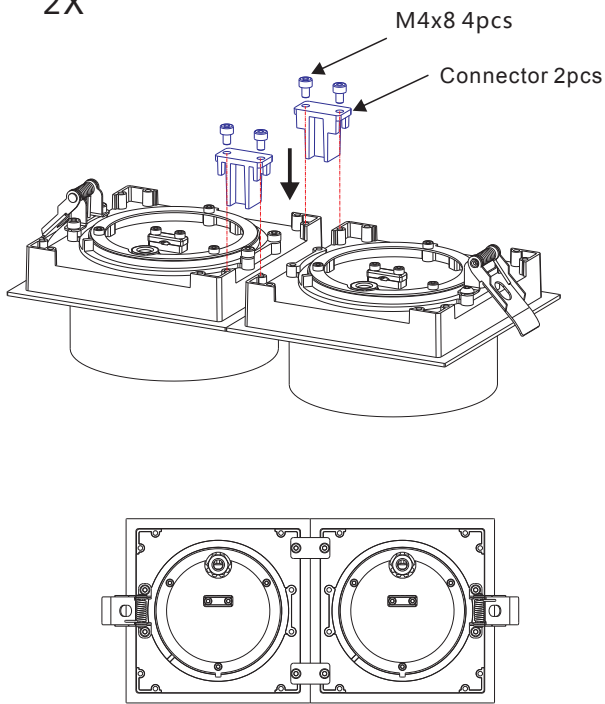

3X

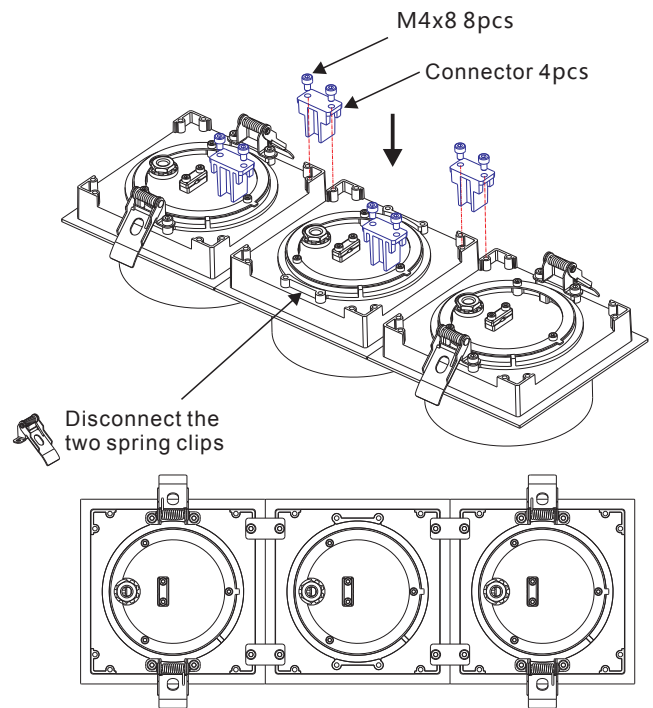

4X

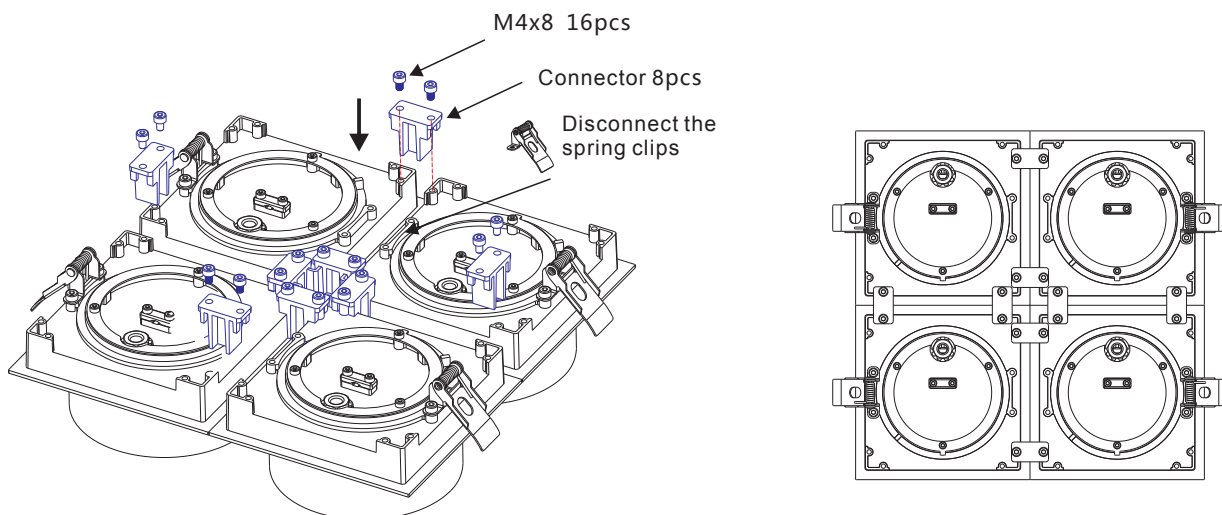

GL12 Installation Instruction

1, Cut Hole

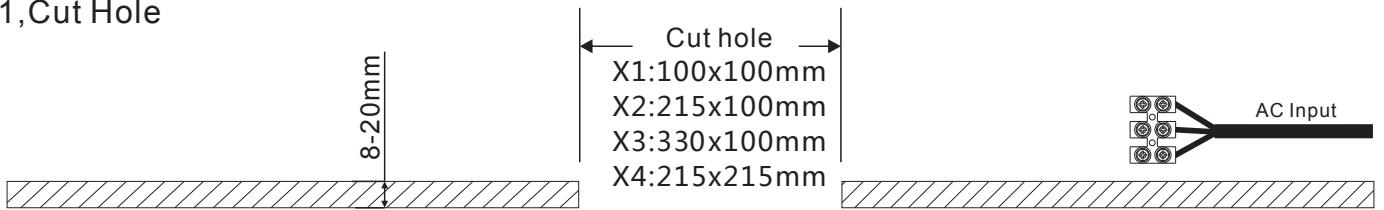

2, Connect Wire

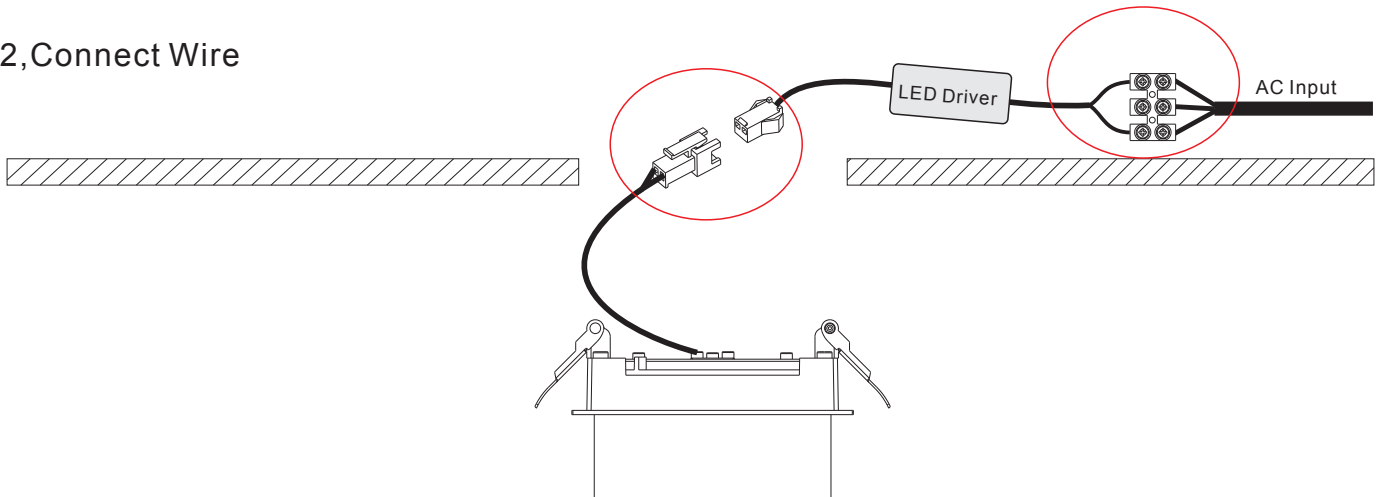

3, Fit the luminaire in the hole

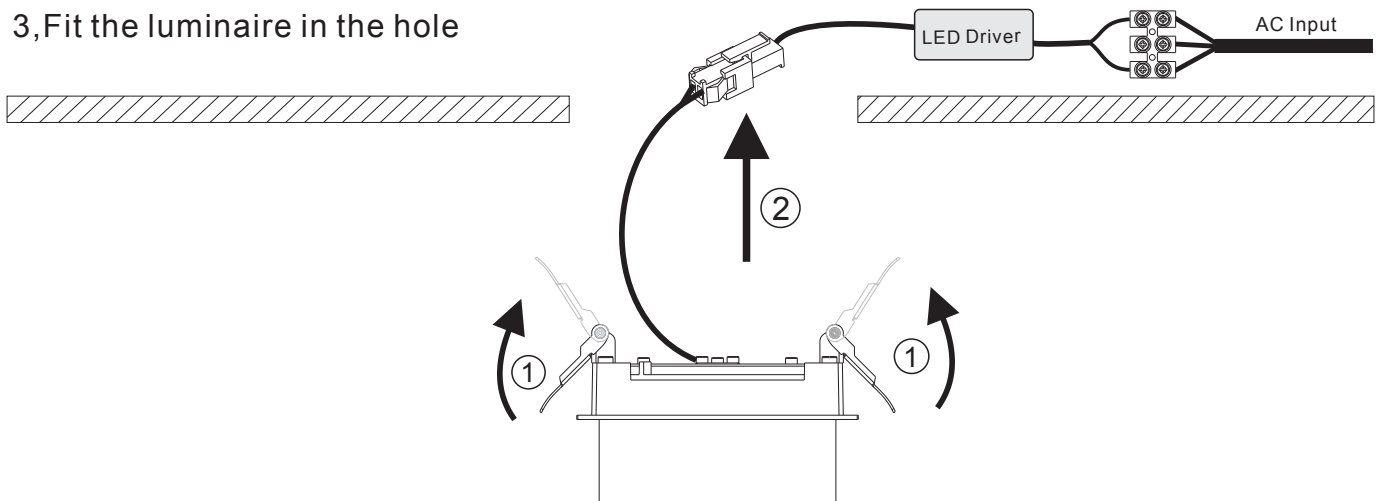

4, Finish

